



DIAMANTEK

DOOR HANDLE FACTORY



pull handles | stainless steel, brass, wooden



Classic

PREMIUM (on request)
Brass CuZn Stainless steel AISI 316 Powder (ESD)

Polished Polished Brushed RAL

STANDARD
Stainless steel AISI 304

Polished Brushed

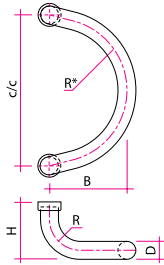

Classic KR

CODE	D	R	R*	B	H	c/c	FIXING
KR-250/25	25	43	100	110	80	250	O
KR-300/25	25	43	150	210	80	300	O
KR-320/25	25	43	160	200	80	320	O
KR-300/32	32	56	150	205	92	300	O
KR-350/32	32	56	175	230	92	350	O
KR-380/32	32	56	190	240	92	380	O
KR-400/32	32	56	200	255	92	400	O

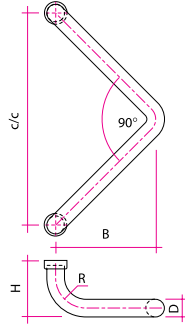

Classic V

CODE	D	R	B	H	c/c	FIXING
V-250/25	25	43	107	80	250	O
V-300/25	25	43	132	80	300	O
V-300/32	32	56	127	92	300	O
V-400/32	32	56	177	92	400	O

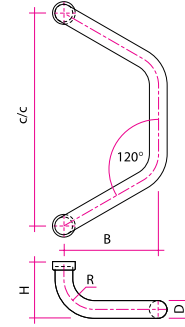

Classic W

CODE	D	R	B	H	c/c	FIXING
W-300/25	25	43	130	80	300	O
W-400/32	32	56	165	92	400	O



Classic

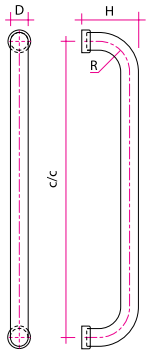

Classic K2

CODE	D	R	H	c/c	FIXING
K2-250/19	19	25	69	250	0
K2-300/19	19	25	69	300	0
K2-400/19	19	25	69	400	0
K2-600/19	19	25	69	600	0
K2-250/20	20	38	70	250	0
K2-300/20	20	38	70	300	0
K2-400/20	20	38	70	400	0
K2-600/20	20	38	70	600	0
K2-800/20	20	38	70	800	0
K2-250/25	25	43	80	250	0
K2-300/25	25	43	80	300	0
K2-400/25	25	43	80	400	0
K2-600/25	25	43	80	600	0
K2-800/25	25	43	80	800	0
K2-1000/25	25	43	80	1000	0
K2-1200/25	25	43	80	1200	0
K2-400/30	30	50	90	400	0
K2-600/30	30	50	90	600	0
K2-800/30	30	50	90	800	0
K2-1000/30	30	50	90	1000	0
K2-1200/30	30	50	90	1200	0
K2-1400/30	30	50	90	1400	0
K2-1600/30	30	50	90	1600	0
K2-400/32	32	56	92	400	0
K2-600/32	32	56	92	600	0
K2-800/32	32	56	92	800	0
K2-1000/32	32	56	92	1000	0
K2-1200/32	32	56	92	1200	0
K2-1400/32	32	56	92	1400	0
K2-1600/32	32	56	92	1600	0
K2-400/38	38	70	108	400	0
K2-600/38	38	70	108	600	0
K2-800/38	38	70	108	800	0
K2-1000/38	38	70	108	1000	0
K2-1200/38	38	70	108	1200	0
K2-1400/38	38	70	108	1400	0
K2-1600/38	38	70	108	1600	0
K2-1800/38	38	70	108	1800	0
K2-2000/38	38	70	108	2000	0
K2-2200/38	38	70	108	2200	0

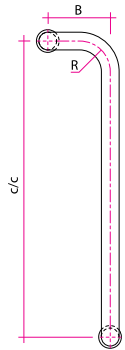

Classic K3

CODE	D	R	B	H	c/c	FIXING
K3-400/25	25	43	86	80	400	0
K3-600/25	25	43	86	80	600	0
K3-800/25	25	43	86	80	800	0
K3-1000/25	25	43	86	80	1000	0
K3-1200/25	25	43	86	80	1200	0
K3-400/30	30	50	100	90	400	0
K3-600/30	30	50	100	90	600	0
K3-800/30	30	50	100	90	800	0
K3-1000/30	30	50	100	90	1000	0
K3-1200/30	30	50	100	90	1200	0
K3-1400/30	30	50	100	90	1400	0
K3-400/32	32	56	112	92	400	0
K3-600/32	32	56	112	92	600	0
K3-800/32	32	56	112	92	800	0
K3-1000/32	32	56	112	92	1000	0
K3-1200/32	32	56	112	92	1200	0
K3-1400/32	32	56	112	92	1400	0
K3-600/38	38	70	140	108	600	0
K3-800/38	38	70	140	108	800	0
K3-1000/38	38	70	140	108	1000	0
K3-1200/38	38	70	140	108	1200	0
K3-1400/38	38	70	140	108	1400	0

Available for Left Hand or Right Hand opening doors.
Please specify LH or RH when ordering.

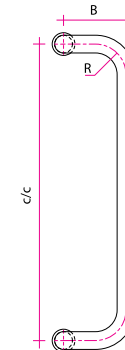

Classic K4

CODE	D	R	B	H	c/c	FIXING
K4-250/19	19	25	100	69	250	0
K4-300/19	19	25	100	69	300	0
K4-400/19	19	25	100	69	400	0
K4-600/19	19	25	100	69	600	0
K4-250/20	20	38	92	75	250	0
K4-300/20	20	38	92	75	300	0
K4-400/20	20	38	92	75	400	0
K4-600/20	20	38	92	75	600	0
K4-800/20	20	38	92	75	800	0
K4-250/25	25	43	86	80	250	0
K4-300/25	25	43	86	80	300	0
K4-400/25	25	43	86	80	400	0
K4-600/25	25	43	86	80	600	0
K4-800/25	25	43	86	80	800	0
K4-1000/25	25	43	86	80	1000	0
K4-1200/25	25	43	86	80	1200	0
K4-400/30	30	50	100	90	400	0
K4-600/30	30	50	100	90	600	0
K4-800/30	30	50	100	90	800	0
K4-1000/30	30	50	100	90	1000	0
K4-1200/30	30	50	100	90	1200	0
K4-1400/30	30	50	100	90	1400	0
K4-1600/30	30	50	100	90	1600	0
K4-400/32	32	56	112	92	400	0
K4-600/32	32	56	112	92	600	0
K4-800/32	32	56	112	92	800	0
K4-1000/32	32	56	112	92	1000	0
K4-1200/32	32	56	112	92	1200	0
K4-1400/32	32	56	112	92	1400	0
K4-1600/32	32	56	112	92	1600	0
K4-600/38	38	70	140	108	600	0
K4-800/38	38	70	140	108	800	0
K4-1000/38	38	70	140	108	1000	0
K4-1200/38	38	70	140	108	1200	0
K4-1400/38	38	70	140	108	1400	0
K4-1600/38	38	70	140	108	1600	0
K4-1800/38	38	70	140	108	1800	0

Classic Step

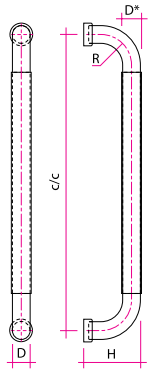

Classic Step A2

CODE	D	D*	R	H	c/c	FIXING
A2-400/28	25	28	43	82	400	O
A2-600/28	25	28	43	82	600	O
A2-800/28	25	28	43	82	800	O
A2-1000/28	25	28	43	82	1000	O
A2-1200/28	25	28	43	82	1200	O
A2-1400/28	25	28	43	82	1400	O
A2-400/35	32	35	56	94	400	O
A2-600/35	32	35	56	94	600	O
A2-800/35	32	35	56	94	800	O
A2-1000/35	32	35	56	94	1000	O
A2-1200/35	32	35	56	94	1200	O
A2-1400/35	32	35	56	94	1400	O
A2-1600/35	32	35	56	94	1600	O
A2-1800/35	32	35	56	94	1800	O
A2-2000/35	32	35	56	94	2000	O
A2-2200/35	32	35	56	94	2200	O

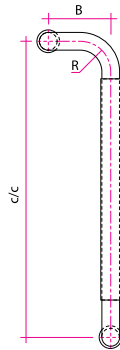

Classic Step A3

CODE	D	D*	R	B	H	c/c	FIXING.
A3-400/28	25	28	43	86	82	400	O
A3-600/28	25	28	43	86	82	600	O
A3-800/28	25	28	43	86	82	800	O
A3-1000/28	25	28	43	86	82	1000	O
A3-1200/28	25	28	43	86	82	1200	O
A3-1400/28	25	28	43	86	82	1400	O
A3-400/35	32	35	56	112	94	400	O
A3-600/35	32	35	56	112	94	600	O
A3-800/35	32	35	56	112	94	800	O
A3-1000/35	32	35	56	112	94	1000	O
A3-1200/35	32	35	56	112	94	1200	O
A3-1400/35	32	35	56	112	94	1400	O

Available for Left Hand or Right Hand opening doors.
Please specify LH or RH when ordering.

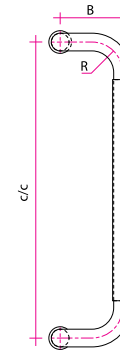







Classic Step A4

CODE	D	D*	R	B	H	c/c	FIXING
A4-400/28	25	28	43	86	82	400	O
A4-600/28	25	28	43	86	82	600	O
A4-800/28	25	28	43	86	82	800	O
A4-1000/28	25	28	43	86	82	1000	O
A4-1200/28	25	28	43	86	82	1200	O
A4-1400/28	25	28	43	86	82	1400	O
A4-400/35	32	35	56	112	94	400	O
A4-600/35	32	35	56	112	94	600	O
A4-800/35	32	35	56	112	94	800	O
A4-1000/35	32	35	56	112	94	1000	O
A4-1200/35	32	35	56	112	94	1200	O
A4-1400/35	32	35	56	112	94	1400	O
A4-1600/35	32	35	56	112	94	1600	O
A4-1800/35	32	35	56	112	94	1800	O
A4-2000/35	32	35	56	112	94	2000	O
A4-2200/35	32	35	56	112	94	2200	O





Classic Oak

PREMIUM (on request)

					
Brown	Black	Polished	Polished	Brushed	RAL

STANDARD

		
Natural	Polished	Brushed

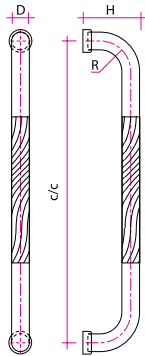

Classic Oak PK2

CODE	D	R	H	c/c	FIXING
PK2-600/32	32	56	92	600	O
PK2-800/32	32	56	92	800	O
PK2-1000/32	32	56	92	1000	O
PK2-800/38	38	70	108	800	O
PK2-1000/38	38	70	108	1000	O
PK2-1200/38	38	70	108	1200	O
PK2-1400/38	38	70	108	1400	O

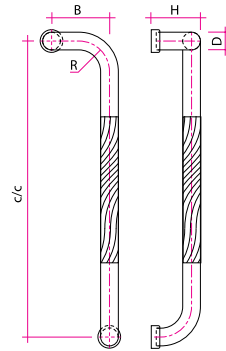

Classic Oak PK3

CODE	D	R	B	H	c/c	FIXING
PK3-600/32	32	56	112	92	600	O
PK3-800/32	32	56	112	92	800	O
PK3-1000/32	32	56	112	92	1000	O
PK3-800/38	38	70	140	108	800	O
PK3-1000/38	38	70	140	108	1000	O
PK3-1200/38	38	70	140	108	1200	O
PK3-1400/38	38	70	140	108	1400	O

Available for Left Hand or Right Hand opening doors.
Please specify LH or RH when ordering.

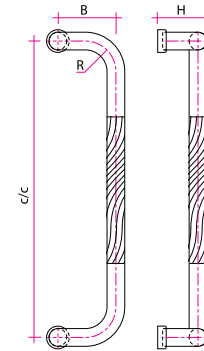

Classic Oak PK4

CODE	D	R	B	H	c/c	FIXING
PK4-600/32	32	56	112	92	600	O
PK4-800/32	32	56	112	92	800	O
PK4-1000/32	32	56	112	92	1000	O
PK4-800/38	38	70	140	108	800	O
PK4-1000/38	38	70	140	108	1000	O
PK4-1200/38	38	70	140	108	1200	O
PK4-1400/38	38	70	140	108	1400	O



Elegance

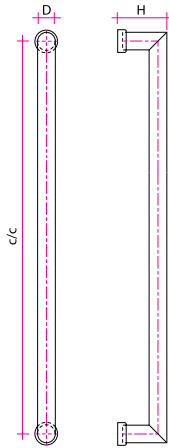

Elegance K2K

CODE	D	H	c/c	FIXING
K2K-250/19	19	79	250	0
K2K-300/19	19	79	300	0
K2K-400/19	19	79	400	0
K2K-600/19	19	79	600	0
K2K-250/20	20	80	250	0
K2K-300/20	20	80	300	0
K2K-400/20	20	80	400	0
K2K-600/20	20	80	600	0
K2K-800/20	20	80	800	0
K2K-250/25	25	85	250	0
K2K-300/25	25	85	300	0
K2K-400/25	25	85	400	0
K2K-600/25	25	85	600	0
K2K-800/25	25	85	800	0
K2K-1000/25	25	85	1000	0
K2K-1200/25	25	85	1200	0
K2K-400/30	30	90	400	0
K2K-600/30	30	90	600	0
K2K-800/30	30	90	800	0
K2K-1000/30	30	90	1000	0
K2K-1200/30	30	90	1200	0
K2K-1400/30	30	90	1400	0
K2K-1600/30	30	90	1600	0
K2K-1800/30	30	90	1800	0
K2K-2000/30	30	90	2000	0
K2K-400/32	32	92	400	0
K2K-600/32	32	92	600	0
K2K-800/32	32	92	800	0
K2K-1000/32	32	92	1000	0
K2K-1200/32	32	92	1200	0
K2K-1400/32	32	92	1400	0
K2K-1600/32	32	92	1600	0
K2K-1800/32	32	92	1800	0
K2K-2000/32	32	92	2000	0
K2K-600/38	38	98	600	0
K2K-800/38	38	98	800	0
K2K-1000/38	38	98	1000	0
K2K-1200/38	38	98	1200	0
K2K-1400/38	38	98	1400	0
K2K-1600/38	38	98	1600	0
K2K-1800/38	38	98	1800	0
K2K-2000/38	38	98	2000	0
K2K-2200/38	38	98	2200	0

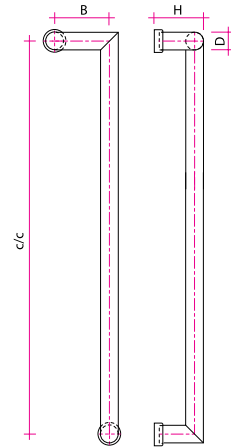

Elegance K3K

CODE	D	B	H	c/c	FIXING
K3K-400/25	25	86	85	400	0
K3K-600/25	25	86	85	600	0
K3K-800/25	25	86	85	800	0
K3K-1000/25	25	86	85	1000	0
K3K-1200/25	25	86	85	1200	0
K3K-400/30	30	100	90	400	0
K3K-600/30	30	100	90	600	0
K3K-800/30	30	100	90	800	0
K3K-1000/30	30	100	90	1000	0
K3K-1200/30	30	100	90	1200	0
K3K-1400/30	30	100	90	1400	0
K3K-400/32	32	112	92	400	0
K3K-600/32	32	112	92	600	0
K3K-800/32	32	112	92	800	0
K3K-1000/32	32	112	92	1000	0
K3K-1200/32	32	112	92	1200	0
K3K-1400/32	32	112	92	1400	0
K3K-400/38	38	140	98	400	0
K3K-600/38	38	140	98	600	0
K3K-800/38	38	140	98	800	0
K3K-1000/38	38	140	98	1000	0
K3K-1200/38	38	140	98	1200	0
K3K-1400/38	38	140	98	1400	0

Available for Left Hand or Right Hand opening doors.
Please specify LH or RH when ordering.

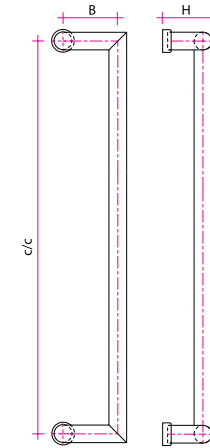

Elegance K4K

CODE	D	B	H	c/c	FIXING
K4K-250/19	19	86	79	250	0
K4K-300/19	19	86	79	300	0
K4K-400/19	19	86	79	400	0
K4K-600/19	19	86	79	600	0
K4K-250/20	20	86	80	250	0
K4K-300/20	20	86	80	300	0
K4K-400/20	20	86	80	400	0
K4K-600/20	20	86	80	600	0
K4K-800/20	20	86	80	800	0
K4K-250/25	25	86	85	250	0
K4K-300/25	25	86	85	300	0
K4K-400/25	25	86	85	400	0
K4K-600/25	25	86	85	600	0
K4K-800/25	25	86	85	800	0
K4K-1000/25	25	86	85	1000	0
K4K-1200/25	25	86	85	1200	0
K4K-400/30	30	100	90	400	0
K4K-600/30	30	100	90	600	0
K4K-800/30	30	100	90	800	0
K4K-1000/30	30	100	90	1000	0
K4K-1200/30	30	100	90	1200	0
K4K-1400/30	30	100	90	1400	0
K4K-1600/30	30	100	90	1600	0
K4K-400/32	32	112	92	400	0
K4K-600/32	32	112	92	600	0
K4K-800/32	32	112	92	800	0
K4K-1000/32	32	112	92	1000	0
K4K-1200/32	32	112	92	1200	0
K4K-1400/32	32	112	92	1400	0
K4K-1600/32	32	112	92	1600	0
K4K-400/38	38	140	98	400	0
K4K-600/38	38	140	98	600	0
K4K-800/38	38	140	98	800	0
K4K-1000/38	38	140	98	1000	0
K4K-1200/38	38	140	98	1200	0
K4K-1400/38	38	140	98	1400	0
K4K-1600/38	38	140	98	1600	0
K4K-1800/38	38	140	98	1800	0
K4K-2000/38	38	140	98	2000	0
K4K-2200/38	38	140	98	2200	0



Elegance Oak

PREMIUM (on request)
Oak wood Oak wood Stainless steel AISI 316 Powder (ESD)
Brown Black Polished Brushed RAL

STANDARD
Oak wood Stainless steel AISI 304
Natural Polished Brushed

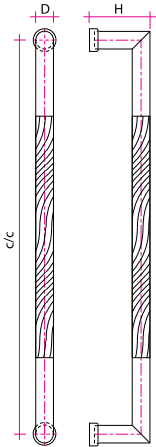

Elegance Oak PK2K

CODE	D	H	c/c	FIXING
PK2K-600/32	32	92	600	O
PK2K-800/32	32	92	800	O
PK2K-1000/32	32	92	1000	O
PK2K-600/38	38	98	600	O
PK2K-800/38	38	98	800	O
PK2K-1000/38	38	98	1000	O
PK2K-1200/38	38	98	1200	O
PK2K-1400/38	38	98	1400	O

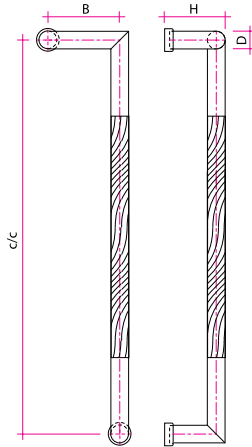

Elegance Oak PK3K

CODE	D	B	H	c/c	FIXING
PK3K-600/32	32	112	92	600	O
PK3K-800/32	32	112	92	800	O
PK3K-1000/32	32	112	92	1000	O
PK3K-600/38	38	140	98	600	O
PK3K-800/38	38	140	98	800	O
PK3K-1000/38	38	140	98	1000	O
PK3K-1200/38	38	140	98	1200	O
PK3K-1400/38	38	140	98	1400	O

Available for Left Hand or Right Hand opening doors.
Please specify LH or RH when ordering.

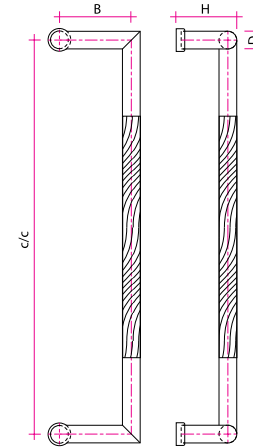

Elegance Oak PK4K

CODE	D	B	H	c/c	FIXING
PK4K-600/32	32	112	92	600	O
PK4K-800/32	32	112	92	800	O
PK4K-1000/32	32	112	92	1000	O
PK4K-600/38	38	140	98	600	O
PK4K-800/38	38	140	98	800	O
PK4K-1000/38	38	140	98	1000	O
PK4K-1200/38	38	140	98	1200	O
PK4K-1400/38	38	140	98	1400	O





Elegance

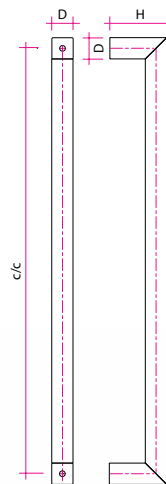

Elegance K2KQ

CODE	D	H	c/c	FIXING
K2KQ-400/30	30x30	80	400	M
K2KQ-600/30	30x30	80	600	M
K2KQ-800/30	30x30	80	800	M
K2KQ-1000/30	30x30	80	1000	M
K2KQ-1200/30	30x30	80	1200	M
K2KQ-1400/30	30x30	80	1400	M
K2KQ-1600/30	30x30	80	1600	M
K2KQ-1800/30	30x30	80	1800	M
K2KQ-2000/30	30x30	80	2000	M
K2KQ-2200/30	30x30	80	2200	M

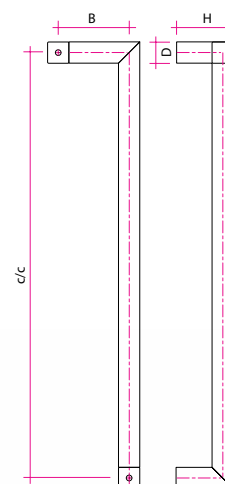

Elegance K3KQ

CODE	D	B	H	c/c	FIXING
K3KQ-400/30	30x30	100	80	400	M
K3KQ-600/30	30x30	100	80	600	M
K3KQ-800/30	30x30	100	80	800	M
K3KQ-1000/30	30x30	100	80	1000	M
K3KQ-1200/30	30x30	100	80	1200	M
K3KQ-1400/30	30x30	100	80	1400	M
K3KQ-1600/30	30x30	100	80	1600	M

Available for Left Hand or Right Hand opening doors.
Please specify LH or RH when ordering.

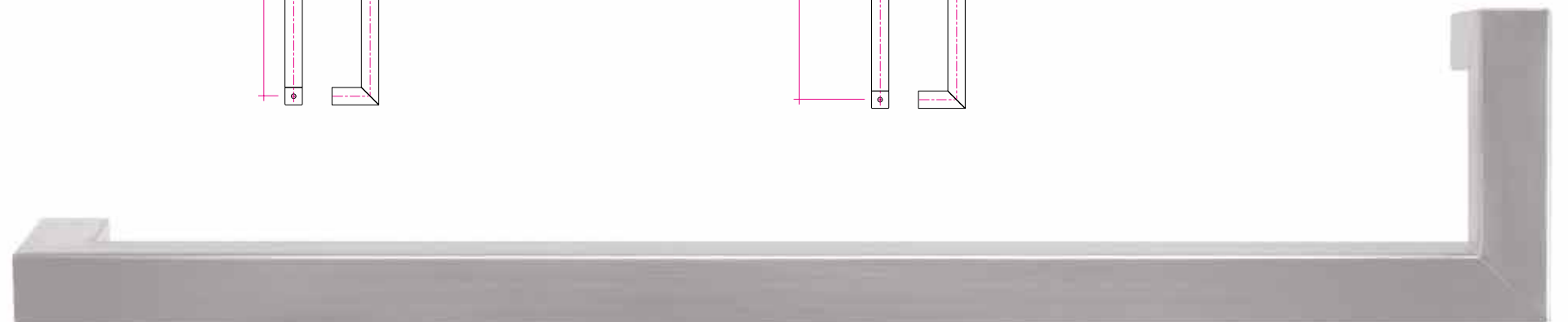



Elegance

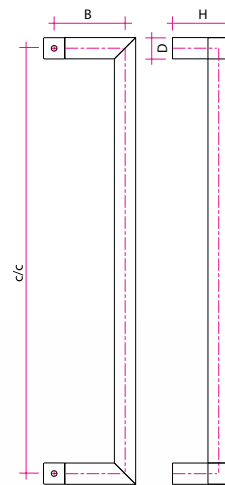

Elegance K4KQ

CODE	D	B	H	c/c	FIXING
K4KQ-400/30	30x30	100	80	400	M
K4KQ-600/30	30x30	100	80	600	M
K4KQ-800/30	30x30	100	80	800	M
K4KQ-1000/30	30x30	100	80	1000	M
K4KQ-1200/30	30x30	100	80	1200	M
K4KQ-1400/30	30x30	100	80	1400	M
K4KQ-1600/30	30x30	100	80	1600	M
K4KQ-1800/30	30x30	100	80	1800	M
K4KQ-2000/30	30x30	100	80	2000	M
K4KQ-2200/30	30x30	100	80	2200	M

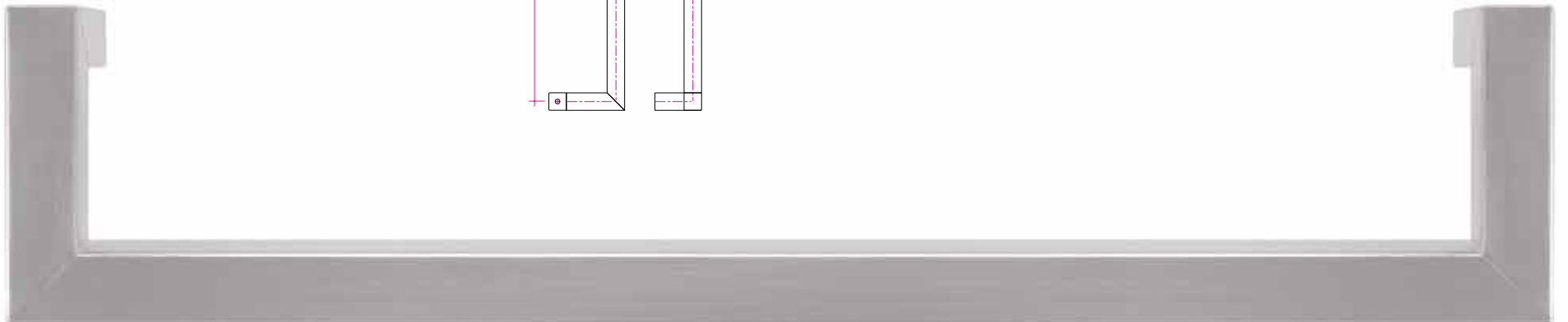



Metropol

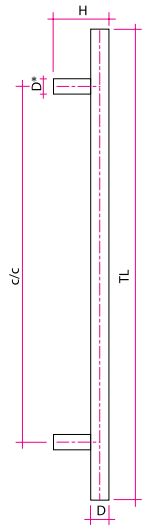

Metropol SQ

CODE	D	D*	H	c/c	TL	FIXING
SQ-400/30	30x30	25x25	80	400	600	M
SQ-600/30	30x30	25x25	80	600	800	M
SQ-800/30	30x30	25x25	80	800	1000	M
SQ-1000/30	30x30	25x25	80	1000	1200	M
SQ-1200/30	30x30	25x25	80	1200	1400	M
SQ-1400/30	30x30	25x25	80	1400	1600	M
SQ-1600/30	30x30	25x25	80	1600	1800	M

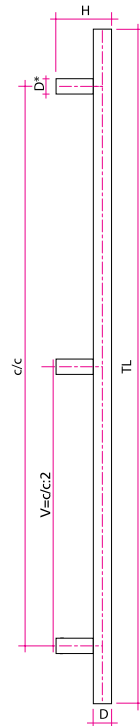

Metropol SQ3

CODE	D	D*	H	c/c	TL	FIXING
SQ3-1000/30	30x30	25x25	80	1000	1200	M
SQ3-1200/30	30x30	25x25	80	1200	1400	M
SQ3-1400/30	30x30	25x25	80	1400	1600	M
SQ3-1600/30	30x30	25x25	80	1600	1800	M
SQ3-1800/30	30x30	25x25	80	1800	2000	M
SQ3-2000/30	30x30	25x25	80	2000	2200	M
SQ3-2200/30	30x30	25x25	80	2200	2400	M

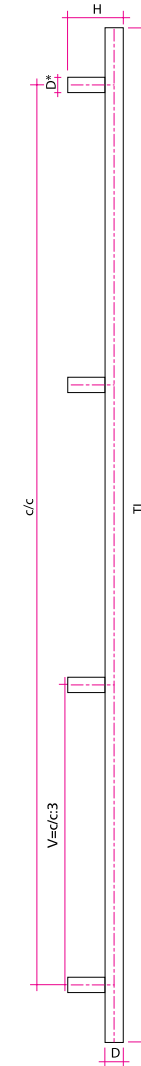

Metropol SQ4

CODE	D	D*	H	c/c	TL	FIXING
SQ4-1600/30	30x30	25x25	80	1600	1800	M
SQ4-1800/30	30x30	25x25	80	1800	2000	M
SQ4-2000/30	30x30	25x25	80	2000	2200	M
SQ4-2200/30	30x30	25x25	80	2200	2400	M
SQ4-2400/30	30x30	25x25	80	2400	2600	M



Metropol

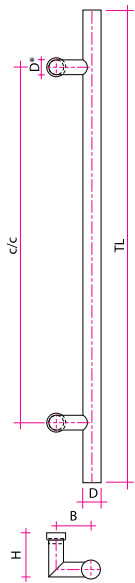

Metropol SK

CODE	D	D*	B	H	c/c	TL	FIXING
SK-400/32	32	25	59	89	400	600	O
SK-600/32	32	25	59	89	600	800	O
SK-800/32	32	25	59	89	800	1000	O
SK-1000/32	32	25	59	89	1000	1200	O
SK-1200/32	32	25	59	89	1200	1400	O
SK-1400/32	32	25	59	89	1400	1600	O
SK-1600/32	32	25	59	89	1600	1800	O
SK-600/38	38	32	77	95	600	800	O
SK-800/38	38	32	77	95	800	1000	O
SK-1000/38	38	32	77	95	1000	1200	O
SK-1200/38	38	32	77	95	1200	1400	O
SK-1400/38	38	32	77	95	1400	1600	O
SK-1600/38	38	32	77	95	1600	1800	O
SK-1800/38	38	32	77	95	1800	2000	O
SK-2000/38	38	32	77	95	2000	2200	O
SK-2200/38	38	32	77	95	2200	2400	O

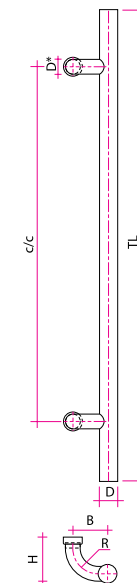

Metropol SR

CODE	D	D*	R	B	H	c/c	TL	FIXING
SR-400/32	32	25	43	59	89	400	600	O
SR-600/32	32	25	43	59	89	600	800	O
SR-800/32	32	25	43	59	89	800	1000	O
SR-1000/32	32	25	43	59	89	1000	1200	O
SR-1200/32	32	25	43	59	89	1200	1400	O
SR-1400/32	32	25	43	59	89	1400	1600	O
SR-1600/32	32	25	43	59	89	1600	1800	O
SR-600/38	38	32	56	77	95	600	800	O
SR-800/38	38	32	56	77	95	800	1000	O
SR-1000/38	38	32	56	77	95	1000	1200	O
SR-1200/38	38	32	56	77	95	1200	1400	O
SR-1400/38	38	32	56	77	95	1400	1600	O
SR-1600/38	38	32	56	77	95	1600	1800	O
SR-1800/38	38	32	56	77	95	1800	2000	O
SR-2000/38	38	32	56	77	95	2000	2200	O
SR-2200/38	38	32	56	77	95	2200	2400	O



Metropol

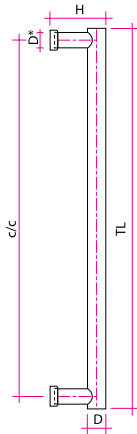

Metropol S

CODE	D	D*	H	c/c	TL	FIXING
S-250/19	19	16	79	250	284	0
S-300/19	19	16	79	300	334	0
S-400/19	19	16	79	400	434	0
S-600/19	19	16	79	600	634	0
S-250/20	20	20	80	250	284	0
S-300/20	20	20	80	300	334	0
S-400/20	20	20	80	400	434	0
S-600/20	20	20	80	600	634	0
S-800/20	20	20	80	800	834	0
S-250/25	25	20	85	250	284	0
S-300/25	25	20	85	300	334	0
S-400/25	25	20	85	400	434	0
S-600/25	25	20	85	600	634	0
S-800/25	25	20	85	800	834	0
S-1000/25	25	20	85	1000	1034	0
S-1200/25	25	20	85	1200	1234	0
S-400/30	30	25	90	400	434	0
S-600/30	30	25	90	600	634	0
S-800/30	30	25	90	800	834	0
S-1000/30	30	25	90	1000	1034	0
S-1200/30	30	25	90	1200	1234	0
S-1400/30	30	25	90	1400	1434	0
S-1600/30	30	25	90	1600	1634	0
S-400/32	32	25	92	400	434	0
S-600/32	32	25	92	600	634	0
S-800/32	32	25	92	800	834	0
S-1000/32	32	25	92	1000	1034	0
S-1200/32	32	25	92	1200	1234	0
S-1400/32	32	25	92	1400	1434	0
S-1600/32	32	25	92	1600	1634	0
S-400/38	38	30	98	400	434	0
S-600/38	38	30	98	600	634	0
S-800/38	38	30	98	800	834	0
S-1000/38	38	30	98	1000	1034	0
S-1200/38	38	30	98	1200	1234	0
S-1400/38	38	30	98	1400	1434	0
S-1600/38	38	30	98	1600	1634	0
S-1800/38	38	30	98	1800	1834	0
S-2000/38	38	30	98	2000	2034	0
S-2200/38	38	30	98	2200	2234	0
S-2000/45	45	30	105	2000	2034	0
S-2200/45	45	30	105	2200	2234	0
S-2400/45	45	30	105	2400	2434	0
S-2600/45	45	30	105	2600	2634	0
S-2800/45	45	30	105	2800	2834	0
S-3000/45	45	30	105	3000	3034	0
S-2400/50	45	30	110	2400	2434	0
S-2600/50	45	30	110	2600	2634	0
S-2800/50	45	30	110	2800	2834	0
S-3000/50	45	30	110	3000	3034	0



PREMIUM (on request)
Brass CuZn Stainless steel AISI 316 Powder (ESD)

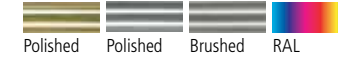

STANDARD
Stainless steel AISI 304

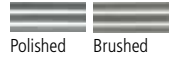

Metropol Old SF

* Brass not available

CODE	D	H	c/c	TL	a	b	c	d	e	FIXING
SF-2000/38	38	88	2000	2040	30	38	20	20	8	custom
SF-2200/38	38	88	2200	2240	30	38	20	20	8	custom
SF-2400/38	38	88	2400	2440	30	38	20	20	8	custom
SF-2000/45	45	95	2000	2040	30	45	20	25	8	custom
SF-2200/45	45	95	2200	2240	30	45	20	25	8	custom
SF-2400/45	45	95	2400	2440	30	45	20	25	8	custom
SF-2600/45	45	95	2600	2640	30	45	20	25	8	custom
SF-2800/45	45	95	2800	2840	30	45	20	25	8	custom
SF-3000/45	45	95	3000	3040	30	45	20	25	8	custom

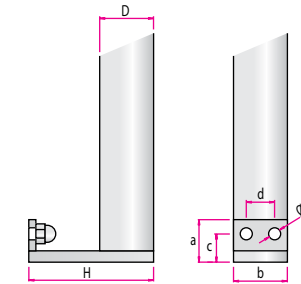



Metropol Old



Metropol Old SQF

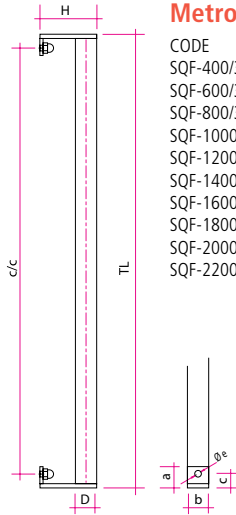

CODE	D	H	c/c	TL	a	b	c	e	FIXING
SQF-400/30	30x30	80	400	440	30	30	20	8	custom
SQF-600/30	30x30	80	600	640	30	30	20	8	custom
SQF-800/30	30x30	80	800	840	30	30	20	8	custom
SQF-1000/30	30x30	80	1000	1040	30	30	20	8	custom
SQF-1200/30	30x30	80	1200	1240	30	30	20	8	custom
SQF-1400/30	30x30	80	1400	1440	30	30	20	8	custom
SQF-1600/30	30x30	80	1600	1640	30	30	20	8	custom
SQF-1800/30	30x30	80	1800	1840	30	30	20	8	custom
SQF-2000/30	30x30	80	2000	2040	30	30	20	8	custom
SQF-2200/30	30x30	80	2200	2240	30	30	20	8	custom



Metropol Old SFO

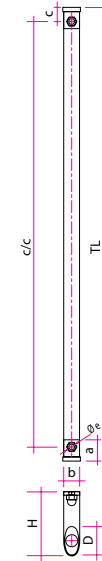

CODE	D	H	c/c	TL	a	b	c	e	FIXING
SFO-400/20-40	20x40	90	400	440	30	23	20	8	custom
SFO-600/20-40	20x40	90	600	640	30	23	20	8	custom
SFO-800/20-40	20x40	90	800	840	30	23	20	8	custom
SFO-1000/20-40	20x40	90	1000	1040	30	23	20	8	custom
SFO-1200/20-40	20x40	90	1200	1240	30	23	20	8	custom
SFO-1400/20-40	20x40	90	1400	1440	30	23	20	8	custom
SFO-1600/20-40	20x40	90	1600	1640	30	23	20	8	custom



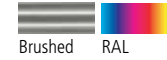

Metropol Old

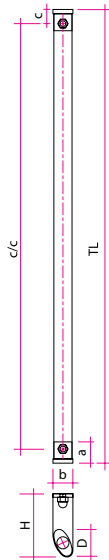

Metropol Old SFOE

CODE	D	H	c/c	TL	a	b	c	e	FIXING
SFOE-400/20-40	20x40	90	400	440	30	28	20	8	custom
SFOE-600/20-40	20x40	90	600	640	30	28	20	8	custom
SFOE-800/20-40	20x40	90	800	840	30	28	20	8	custom
SFOE-1000/20-40	20x40	90	1000	1040	30	28	20	8	custom
SFOE-1200/20-40	20x40	90	1200	1240	30	28	20	8	custom
SFOE-1400/20-40	20x40	90	1400	1440	30	28	20	8	custom
SFOE-1600/20-40	20x40	90	1600	1640	30	28	20	8	custom

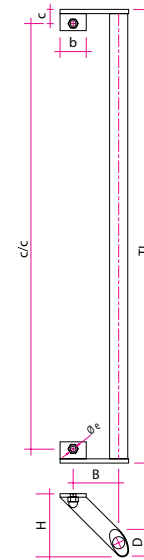

Metropol Old SFOE*

CODE	D	B	H	c/c	TL	a	b	c	e	FIXING
SFOE*-400/20-40	20x40	64	90	400	440	30	37	20	8	custom
SFOE*-600/20-40	20x40	64	90	600	640	30	37	20	8	custom
SFOE*-800/20-40	20x40	64	90	800	840	30	37	20	8	custom
SFOE*-1000/20-40	20x40	64	90	1000	1040	30	37	20	8	custom
SFOE*-1200/20-40	20x40	64	90	1200	1240	30	37	20	8	custom
SFOE*-1400/20-40	20x40	64	90	1400	1440	30	37	20	8	custom
SFOE*-1600/20-40	20x40	64	90	1600	1640	30	37	20	8	custom

Metropol Oak

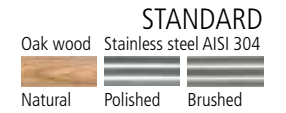

Metropol Oak PSO

CODE	D	D*	H	c/c	TL	FIXING
PSO-400/32	32	25	92	400	600	O
PSO-600/32	32	25	92	600	800	O
PSO-800/32	32	25	92	800	1000	O
PSO-600/38	38	30	98	600	800	O
PSO-800/38	38	30	98	800	1000	O
PSO-1000/38	38	30	98	1000	1200	O
PSO-1200/38	38	30	98	1200	1400	O
PSO-1800/50	50	30	110	1800	2000	O
PSO-2000/50	50	30	110	2000	2200	O
PSO-2200/50	50	30	110	2200	2400	O
PSO-2400/50	50	30	110	2400	2600	O

Metropol Oak PS3

CODE	D	D*	H	c/c	TL	FIXING
PS3-1000/32	32	25	92	1000	1200	O
PS3-1200/32	32	25	92	1200	1400	O
PS3-1400/32	32	25	92	1400	1600	O
PS3-1600/32	32	25	92	1600	1800	O
PS3-1200/38	38	30	98	1200	1400	O
PS3-1400/38	38	30	98	1400	1600	O
PS3-1600/38	38	30	98	1600	1800	O
PS3-1800/38	38	30	98	1800	2000	O
PS3-2000/38	38	30	98	2000	2200	O

Metropol Oak PS4

CODE	D	D*	H	c/c	TL	FIXING
PS4-1600/32	32	25	92	1600	1800	O
PS4-1800/32	32	25	92	1800	2000	O
PS4-2000/32	32	25	92	2000	2200	O
PS4-2200/32	32	25	92	2200	2400	O
PS4-2400/32	32	25	92	2400	2600	O
PS4-1800/38	38	30	98	1800	2000	O
PS4-2000/38	38	30	98	2000	2200	O
PS4-2200/38	38	30	98	2200	2400	O
PS4-2400/38	38	30	98	2400	2600	O

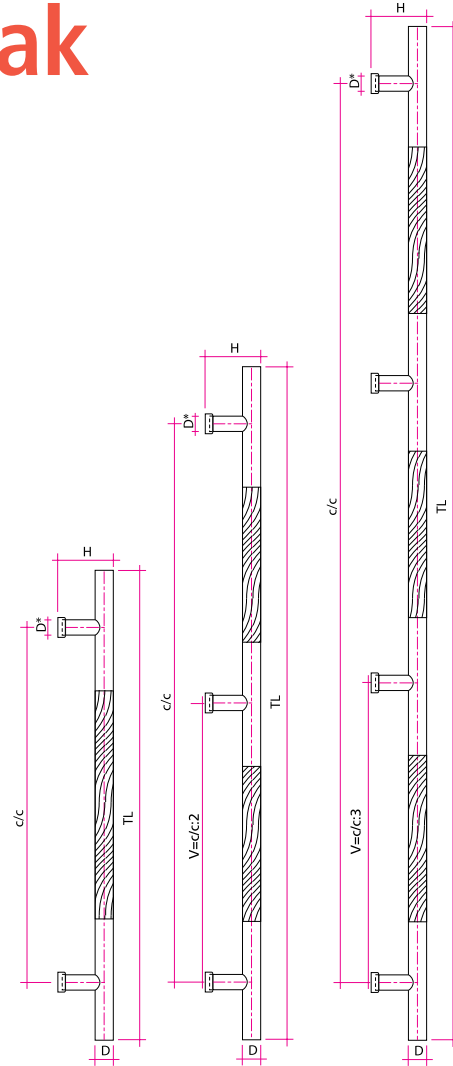

Metropol Oak PS

CODE	D	D*	H	c/c	TL	FIXING
PS-400/32	32	25	92	400	434	O
PS-600/32	32	25	92	600	634	O
PS-800/32	32	25	92	800	834	O
PS-600/38	38	30	98	600	634	O
PS-800/38	38	30	98	800	834	O
PS-1000/38	38	30	98	1000	1034	O
PS-1200/38	38	30	98	1200	1234	O
PS-1800/50	50	30	110	1800	1834	O
PS-2000/50	50	30	110	2000	2034	O
PS-2200/50	50	30	110	2200	2234	O
PS-2400/50	50	30	110	2400	2434	O

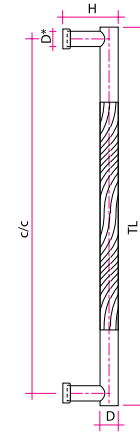

Metropol Oak

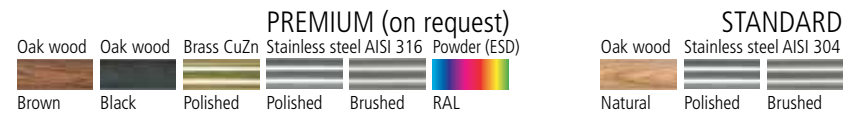

Metropol Oak P0

CODE	D	D*	H	c/c	TL	FIXING
PO-300/32	32	25	92	300	400	O
PO-400/32	32	25	92	400	600	O
PO-600/32	32	25	92	600	800	O
PO-400/38	38	30	98	400	600	O
PO-600/38	38	30	98	600	800	O
PO-800/38	38	30	98	800	1000	O
PO-1000/38	38	30	98	1000	1200	O

Metropol Oak P3

CODE	D	D*	H	c/c	TL	FIXING
P3-1000/32	32	25	92	1000	1200	O
P3-1200/32	32	25	92	1200	1400	O
P3-1400/32	32	25	92	1400	1600	O
P3-1200/38	38	30	98	1200	1400	O
P3-1400/38	38	30	98	1400	1600	O
P3-1600/38	38	30	98	1600	1800	O
P3-1800/38	38	30	98	1800	2000	O
P3-2000/38	38	30	98	2000	2200	O

Metropol Oak P4

CODE	D	D*	H	c/c	TL	FIXING
P4-1600/32	32	25	92	1600	1800	O
P4-1800/32	32	25	92	1800	2000	O
P4-2000/32	32	25	92	2000	2200	O
P4-2200/32	32	25	92	2200	2400	O
P4-2400/32	32	25	92	2400	2600	O
P4-1800/38	38	30	98	1800	2000	O
P4-2000/38	38	30	98	2000	2200	O
P4-2200/38	38	30	98	2200	2400	O
P4-2400/38	38	30	98	2400	2600	O

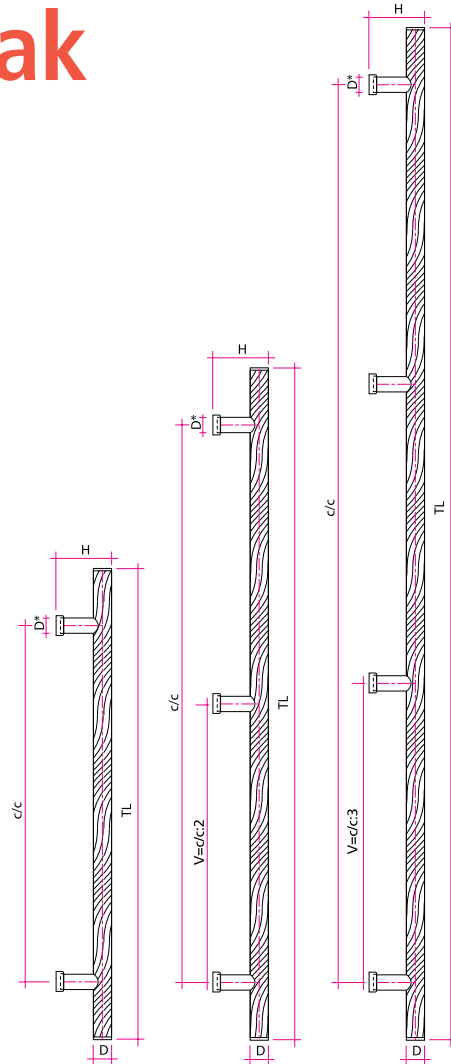

Metropol Oak P

CODE	D	D*	H	c/c	TL	FIXING
P-2000/50	50	30	110	2000	2034	O
P-2200/50	50	30	110	2200	2234	O
P-2400/50	50	30	110	2400	2434	O

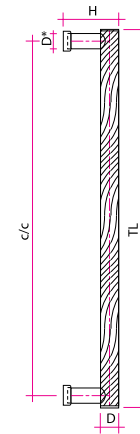

Metropol Wooden

PREMIUM (on request)

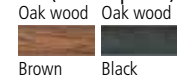

STANDARD

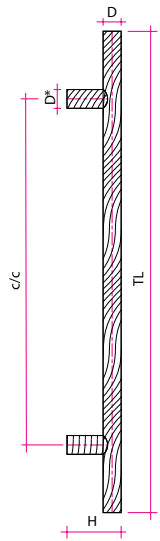

Metropol Wooden PP

CODE	D	D*	H	c/c	TL	FIXING
PP-300/32	32	25	82	300	400	custom
PP-400/32	32	25	82	400	600	custom
PP-600/32	32	25	82	600	800	custom
PP-400/38	38	30	88	400	600	custom
PP-600/38	38	30	88	600	800	custom
PP-800/38	38	30	88	800	1000	custom
PP-1000/38	38	30	88	1000	1200	custom

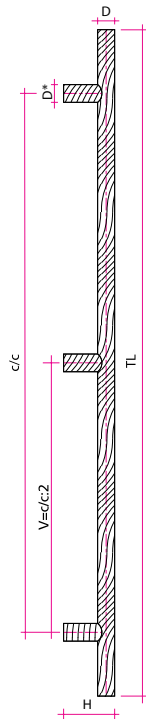

Metropol Wooden PP3

CODE	D	D*	H	c/c	TL	FIXING
PP3-1000/32	32	25	92	1000	1200	custom
PP3-1200/32	32	25	92	1200	1400	custom
PP3-1400/32	32	25	92	1400	1600	custom
PP3-1200/38	38	30	98	1200	1400	custom
PP3-1400/38	38	30	98	1400	1600	custom
PP3-1600/38	38	30	98	1600	1800	custom
PP3-1800/38	38	30	98	1800	2000	custom
PP3-2000/38	38	30	98	2000	2200	custom

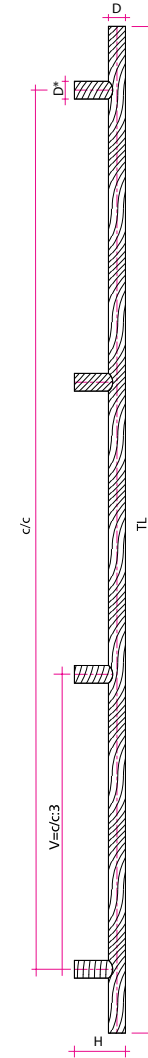

Metropol Wooden PP4

CODE	D	D*	H	c/c	TL	FIXING
PP4-1600/32	32	25	92	1600	1800	custom
PP4-1800/32	32	25	92	1800	2000	custom
PP4-2000/32	32	25	92	2000	2200	custom
PP4-2200/32	32	25	92	2200	2400	custom
PP4-2400/32	32	25	92	2400	2600	custom
PP4-1800/38	38	30	98	1800	2000	custom
PP4-2000/38	38	30	98	2000	2200	custom
PP4-2200/38	38	30	98	2200	2400	custom
PP4-2400/38	38	30	98	2400	2600	custom

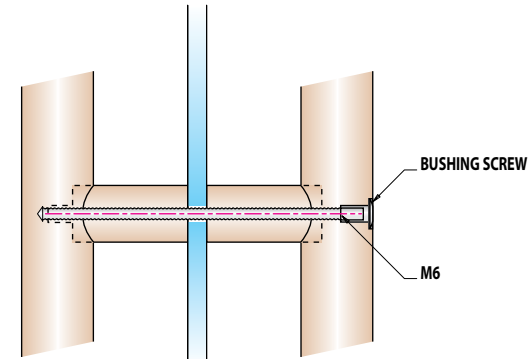

Metropol Wooden fixing

18



Orders are possible with custom c/c and TL mm specification.

See page 30 for other FIXING options.

Metropol Oak

PREMIUM (on request)
Oak wood Oak wood Stainless steel AISI 316 Powder (ESD)
Brown Black Polished Brushed RAL

STANDARD
Oak wood Stainless steel AISI 304
Natural Polished Brushed

Metropol Oak PSK

CODE	D	D*	B	H	c/c	TL	FIXING
PSK-400/32	32	25	59	89	400	600	O
PSK-600/32	32	25	59	89	600	800	O
PSK-800/32	32	25	59	89	800	1000	O
PSK-600/38	38	32	77	95	600	800	O
PSK-800/38	38	32	77	95	800	1000	O
PSK-1000/38	38	32	77	95	1000	1200	O
PSK-1200/38	38	32	77	95	1200	1400	O
PSK-1800/50	50	32	83	101	1800	2000	O
PSK-2000/50	50	32	83	101	2000	2200	O
PSK-2200/50	50	32	83	101	2200	2400	O
PSK-2400/50	50	32	83	101	2400	2600	O

Metropol Oak PSK3

CODE	D	D*	B	H	c/c	TL	FIXING
PSK3-1000/32	32	25	59	89	1000	1200	O
PSK3-1200/32	32	25	59	89	1200	1400	O
PSK3-1400/32	32	25	59	89	1400	1600	O
PSK3-1600/32	32	25	59	89	1600	1800	O
PSK3-1200/38	38	32	77	95	1200	1400	O
PSK3-1400/38	38	32	77	95	1400	1600	O
PSK3-1600/38	38	32	77	95	1600	1800	O
PSK3-1800/38	38	32	77	95	1800	2000	O
PSK3-2000/38	38	32	77	95	2000	2200	O

Metropol Oak PSK4

CODE	D	D*	B	H	c/c	TL	FIXING
PSK4-1600/32	32	25	59	89	1600	1800	O
PSK4-1800/32	32	25	59	89	1800	2000	O
PSK4-2000/32	32	25	59	89	2000	2200	O
PSK4-2200/32	32	25	59	89	2200	2400	O
PSK4-2400/32	32	25	59	89	2400	2600	O
PSK4-1800/38	38	32	77	95	1800	2000	O
PSK4-2000/38	38	32	77	95	2000	2200	O
PSK4-2200/38	38	32	77	95	2200	2400	O
PSK4-2400/38	38	32	77	95	2400	2600	O



Metropol Oak

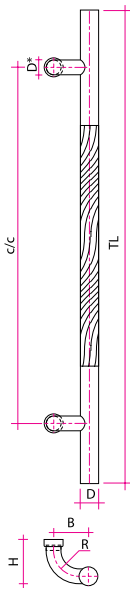

Metropol Oak PSR

CODE	D	D*	R	B	H	c/c	TL	FIXING
PSR-400/32	32	25	43	59	89	400	600	O
PSR-600/32	32	25	43	59	89	600	800	O
PSR-800/32	32	25	43	59	89	800	1000	O
PSR-600/38	38	32	56	77	95	600	800	O
PSR-800/38	38	32	56	77	95	800	1000	O
PSR-1000/38	38	32	56	77	95	1000	1200	O
PSR-1200/38	38	32	56	77	95	1200	1400	O
PSR-1800/50	50	32	56	83	101	1800	2000	O
PSR-2000/50	50	32	56	83	101	2000	2200	O
PSR-2200/50	50	32	56	83	101	2200	2400	O
PSR-2400/50	50	32	56	83	101	2400	2600	O

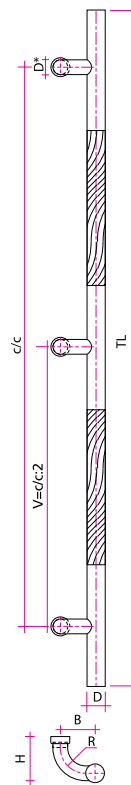

Metropol Oak PSR3

CODE	D	D*	R	B	H	c/c	TL	FIXING
PSR3-1000/32	32	25	43	59	79	1000	1200	O
PSR3-1200/32	32	25	43	59	79	1200	1400	O
PSR3-1400/32	32	25	43	59	79	1400	1600	O
PSR3-1600/32	32	25	43	59	79	1600	1800	O
PSR3-1200/38	38	32	56	77	95	1200	1400	O
PSR3-1400/38	38	32	56	77	95	1400	1600	O
PSR3-1600/38	38	32	56	77	95	1600	1800	O
PSR3-1800/38	38	32	56	77	95	1800	2000	O
PSR3-2000/38	38	32	56	77	95	2000	2200	O

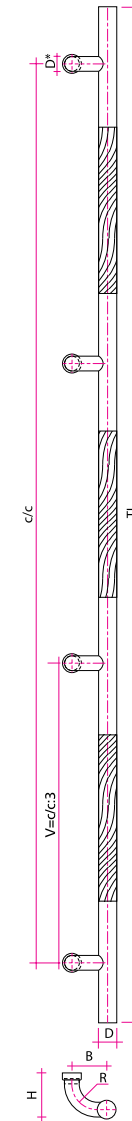

Metropol Oak PSR4

CODE	D	D*	R	B	H	c/c	TL	FIXING
PSR4-1600/32	32	25	43	59	79	1600	1800	O
PSR4-1800/32	32	25	43	59	79	1800	2000	O
PSR4-2000/32	32	25	43	59	79	2000	2200	O
PSR4-2200/32	32	25	43	59	79	2200	2400	O
PSR4-2400/32	32	25	43	59	79	2400	2600	O
PSR4-1800/38	38	32	56	77	95	1800	2000	O
PSR4-2000/38	38	32	56	77	95	2000	2200	O
PSR4-2200/38	38	32	56	77	95	2200	2400	O
PSR4-2400/38	38	32	56	77	95	2400	2600	O



Stylish

PREMIUM (on request)
Brass CuZn Stainless steel AISI 316 Powder (ESD)



STANDARD
Stainless steel AISI 304

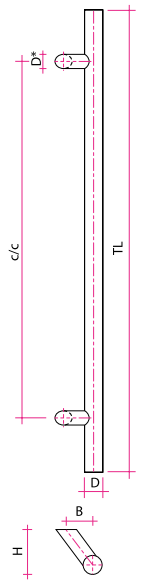

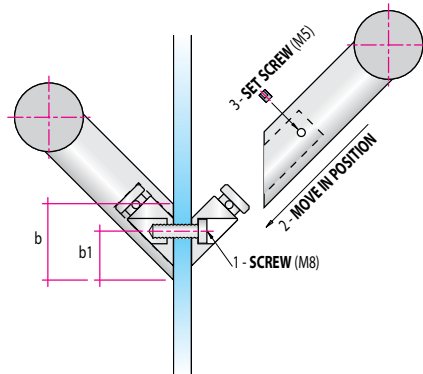

Stylish SC

CODE	D	D*	B	H	c/c	TL	b	b1	FIXING
SC-400/32	32	25	60	82	400	600	35	24	Custom
SC-600/32	32	25	60	82	600	800	35	24	Custom
SC-800/32	32	25	60	82	800	1000	35	24	Custom
SC-1000/32	32	25	60	82	1000	1200	35	24	Custom
SC-1200/32	32	25	60	82	1200	1400	35	24	Custom
SC-1400/32	32	25	60	82	1400	1600	35	24	Custom
SC-1600/32	32	25	60	82	1600	1800	35	24	Custom
SC-600/38	38	30	63	88	600	800	42	27	Custom
SC-800/38	38	30	63	88	800	1000	42	27	Custom
SC-1000/38	38	30	63	88	1000	1200	42	27	Custom
SC-1200/38	38	30	63	88	1200	1400	42	27	Custom
SC-1400/38	38	30	63	88	1400	1600	42	27	Custom
SC-1600/38	38	30	63	88	1600	1800	42	27	Custom
SC-1800/38	38	30	63	88	1800	2000	42	27	Custom
SC-2000/38	38	30	63	88	2000	2200	42	27	Custom
SC-2200/38	38	30	63	88	2200	2400	42	27	Custom

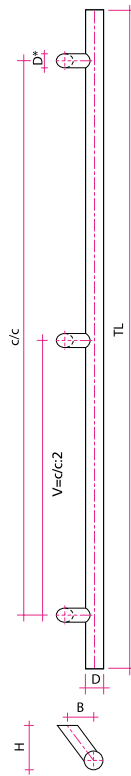

Stylish SC fixing



Stylish SC3

CODE	D	D*	B	H	c/c	TL	b	b1	FIXING
SC3-1000/32	32	25	60	82	1000	1200	35	24	Custom
SC3-1200/32	32	25	60	82	1200	1400	35	24	Custom
SC3-1400/32	32	25	60	82	1400	1600	35	24	Custom
SC3-1600/32	32	25	60	82	1600	1800	35	24	Custom
SC3-1800/32	32	25	60	82	1800	2000	35	24	Custom
SC3-2000/32	32	25	60	82	2000	2200	35	24	Custom
SC3-1000/38	38	30	63	88	1000	1200	42	27	Custom
SC3-1200/38	38	30	63	88	1200	1400	42	27	Custom
SC3-1400/38	38	30	63	88	1400	1600	42	27	Custom
SC3-1600/38	38	30	63	88	1600	1800	42	27	Custom
SC3-1800/38	38	30	63	88	1800	2000	42	27	Custom
SC3-2000/38	38	30	63	88	2000	2200	42	27	Custom
SC3-2200/38	38	30	63	88	2200	2400	42	27	Custom
SC3-2400/38	38	30	63	88	2400	2600	42	27	Custom

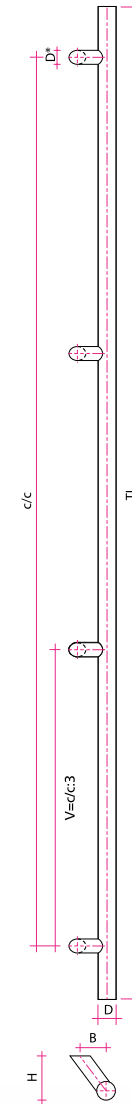

Stylish SC4

CODE	D	D*	B	H	c/c	TL	b	b1	Fixing
SC4-1600/32	32	25	60	82	1600	1800	35	24	Custom
SC4-1800/32	32	25	60	82	1800	2000	35	24	Custom
SC4-2000/32	32	25	60	82	2000	2200	35	24	Custom
SC4-2200/32	32	25	60	82	2200	2400	35	24	Custom
SC4-2400/32	32	25	60	82	2400	2600	35	24	Custom
SC4-1600/38	38	30	63	88	1600	1800	42	27	Custom
SC4-1800/38	38	30	63	88	1800	2000	42	27	Custom
SC4-2000/38	38	30	63	88	2000	2200	42	27	Custom
SC4-2200/38	38	30	63	88	2200	2400	42	27	Custom
SC4-2400/38	38	30	63	88	2400	2600	42	27	Custom



Stylish

PREMIUM (on request)
Stainless steel AISI 316 Powder (ESD)



STANDARD
Stainless steel AISI 304



Stylish SQC

CODE	D	D*	B	H	c/c	TL	b	b1	FIXING
SQC-400/30	30x30	25x25	60	81	400	600	35	24	Custom
SQC-600/30	30x30	25x25	60	81	600	800	35	24	Custom
SQC-800/30	30x30	25x25	60	81	800	1000	35	24	Custom
SQC-1000/30	30x30	25x25	60	81	1000	1200	35	24	Custom
SQC-1200/30	30x30	25x25	60	81	1200	1400	35	24	Custom
SQC-1400/30	30x30	25x25	60	81	1400	1600	35	24	Custom
SQC-1600/30	30x30	25x25	60	81	1600	1800	35	24	Custom

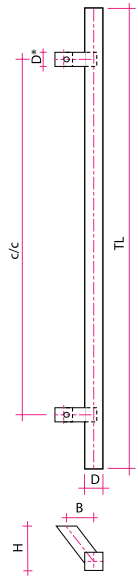

Stylish SQC3

CODE	D	D*	B	H	c/c	TL	b	b1	FIXING
SQC3-1000/30	30x30	25x25	60	81	1000	1200	35	24	Custom
SQC3-1200/30	30x30	25x25	60	81	1200	1400	35	24	Custom
SQC3-1400/30	30x30	25x25	60	81	1400	1600	35	24	Custom
SQC3-1600/30	30x30	25x25	60	81	1600	1800	35	24	Custom
SQC3-1800/30	30x30	25x25	60	81	1800	2000	35	24	Custom
SQC3-2000/30	30x30	25x25	60	81	2000	2200	35	24	Custom

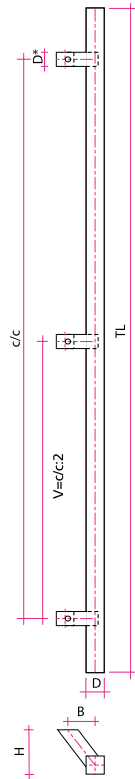

Stylish SQC4

CODE	D	D*	B	H	c/c	TL	b	b1	FIXING
SQC4-1600/30	30x30	25x25	60	81	1600	1800	35	24	Custom
SQC4-1800/30	30x30	25x25	60	81	1800	2000	35	24	Custom
SQC4-2000/30	30x30	25x25	60	81	2000	2200	35	24	Custom
SQC4-2200/30	30x30	25x25	60	81	2200	2400	35	24	Custom
SQC4-2400/30	30x30	25x25	60	81	2400	2600	35	24	Custom

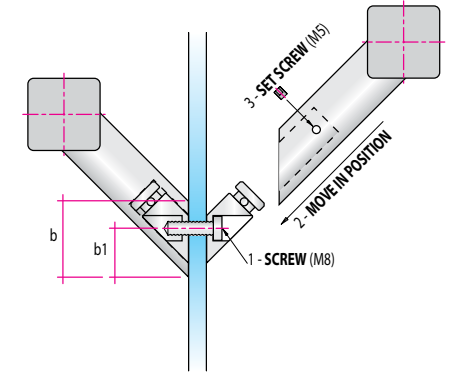
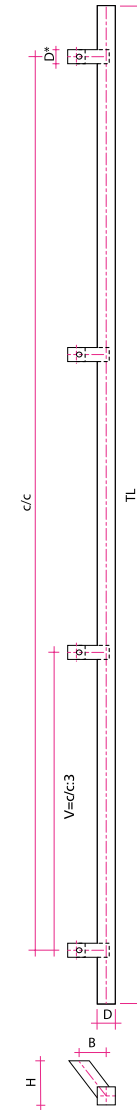

Stylish SQC fixing

Stylish Oak

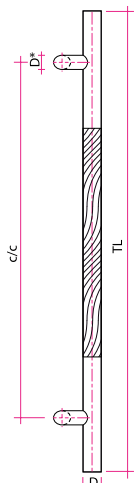
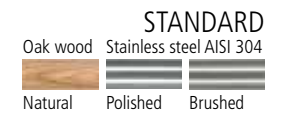

Stylish Oak PSC

CODE	D	D*	B	H	c/c	TL	b	b1	FIXING
PSC-400/32	32	25	60	82	400	600	35	24	Custom
PSC-600/32	32	25	60	82	600	800	35	24	Custom
PSC-800/32	32	25	60	82	800	1000	35	24	Custom
PSC-600/38	38	30	63	88	600	800	42	27	Custom
PSC-800/38	38	30	63	88	800	1000	42	27	Custom
PSC-1000/38	38	30	63	88	1000	1200	42	27	Custom
PSC-1200/38	38	30	63	88	1200	1400	42	27	Custom
PSC-1800/50	50	30	67	98	1800	2000	42	27	Custom
PSC-2000/50	50	30	67	98	2000	2200	42	27	Custom
PSC-2200/50	50	30	67	98	2200	2400	42	27	Custom
PSC-2400/50	50	30	67	98	2400	2600	42	27	Custom

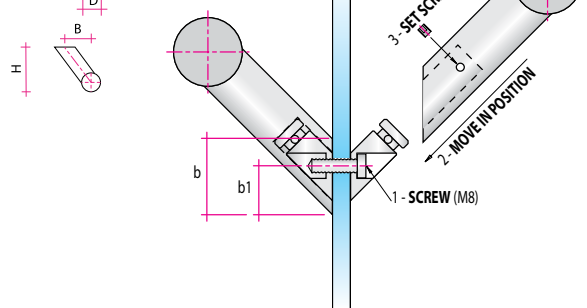

Stylish Oak PSC fixing

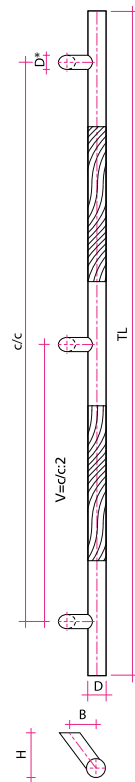

Stylish Oak PSC3

CODE	D	D*	B	H	c/c	TL	b	b1	FIXING
PSC3-1000/32	32	25	60	82	1000	1200	35	24	Custom
PSC3-1200/32	32	25	60	82	1200	1400	35	24	Custom
PSC3-1400/32	32	25	60	82	1400	1600	35	24	Custom
PSC3-1600/32	32	25	60	82	1600	1800	35	24	Custom
PSC3-1200/38	38	30	63	88	1200	1400	42	27	Custom
PSC3-1400/38	38	30	63	88	1400	1600	42	27	Custom
PSC3-1600/38	38	30	63	88	1600	1800	42	27	Custom
PSC3-1800/38	38	30	63	88	1800	2000	42	27	Custom
PSC3-2000/38	38	30	63	88	2000	2200	42	27	Custom

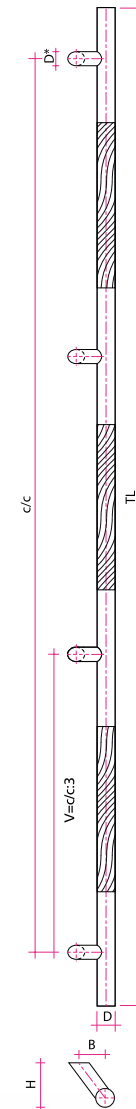

Stylish Oak PSC4

CODE	D	D*	B	H	c/c	TL	b	b1	FIXING
PSC4-1600/32	32	25	60	82	1600	1800	35	24	Custom
PSC4-1800/32	32	25	60	82	1800	2000	35	24	Custom
PSC4-2000/32	32	25	60	82	2000	2200	35	24	Custom
PSC4-2200/32	32	25	60	82	2200	2400	35	24	Custom
PSC4-2400/32	32	25	60	82	2400	2600	35	24	Custom
PSC4-1800/38	38	30	63	88	1800	2000	42	27	Custom
PSC4-2000/38	38	30	63	88	2000	2200	42	27	Custom
PSC4-2200/38	38	30	63	88	2200	2400	42	27	Custom
PSC4-2400/38	38	30	63	88	2400	2600	42	27	Custom



City

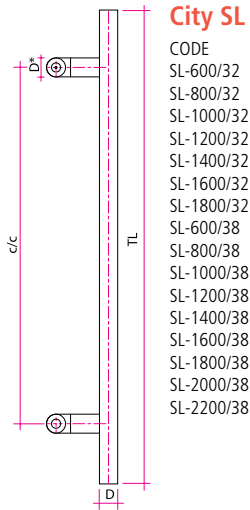

City SL

CODE	D	D*	B	H	a	c/c	TL	FIXING
SL-600/32	32	35	90	82	40	600	800	custom
SL-800/32	32	35	90	82	40	800	1000	custom
SL-1000/32	32	35	90	82	40	1000	1200	custom
SL-1200/32	32	35	90	82	40	1200	1400	custom
SL-1400/32	32	35	90	82	40	1400	1600	custom
SL-1600/32	32	35	90	82	40	1600	1800	custom
SL-1800/32	32	35	90	82	40	1800	2000	custom
SL-600/38	38	35	93	88	40	600	800	custom
SL-800/38	38	35	93	88	40	800	1000	custom
SL-1000/38	38	35	93	88	40	1000	1200	custom
SL-1200/38	38	35	93	88	40	1200	1400	custom
SL-1400/38	38	35	93	88	40	1400	1600	custom
SL-1600/38	38	35	93	88	40	1600	1800	custom
SL-1800/38	38	35	93	88	40	1800	2000	custom
SL-2000/38	38	35	93	88	40	2000	2200	custom
SL-2200/38	38	35	93	88	40	2200	2400	custom

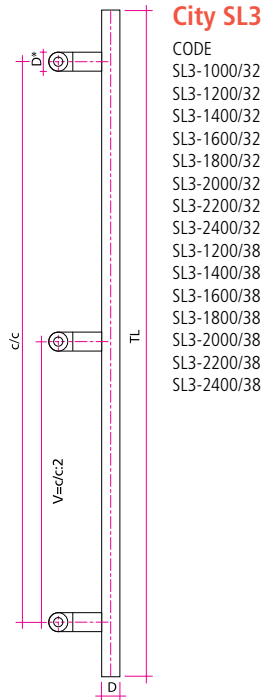

City SL3

CODE	D	D*	B	H	a	c/c	TL	FIXING
SL3-1000/32	32	35	90	82	40	1000	1200	custom
SL3-1200/32	32	35	90	82	40	1200	1400	custom
SL3-1400/32	32	35	90	82	40	1400	1600	custom
SL3-1600/32	32	35	90	82	40	1600	1800	custom
SL3-1800/32	32	35	90	82	40	1800	2000	custom
SL3-2000/32	32	35	90	82	40	2000	2200	custom
SL3-2200/32	32	35	90	82	40	2200	2400	custom
SL3-2400/32	32	35	90	82	40	2400	2600	custom
SL3-1200/38	38	35	93	88	40	1200	1400	custom
SL3-1400/38	38	35	93	88	40	1400	1600	custom
SL3-1600/38	38	35	93	88	40	1600	1800	custom
SL3-1800/38	38	35	93	88	40	1800	2000	custom
SL3-2000/38	38	35	93	88	40	2000	2200	custom
SL3-2200/38	38	35	93	88	40	2200	2400	custom
SL3-2400/38	38	35	93	88	40	2400	2600	custom

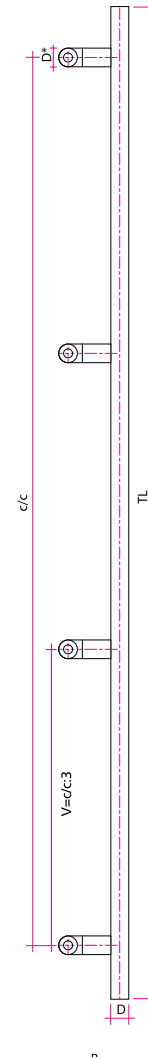

City SL4

CODE	D	D*	B	H	a	c/c	TL	FIXING
SL4-1600/32	32	35	90	82	40	1600	1800	custom
SL4-1800/32	32	35	90	82	40	1800	2000	custom
SL4-2000/32	32	35	90	82	40	2000	2200	custom
SL4-2200/32	32	35	90	82	40	2200	2400	custom
SL4-2400/32	32	35	90	82	40	2400	2600	custom
SL4-1600/38	38	35	93	88	40	1600	1800	custom
SL4-1800/38	38	35	93	88	40	1800	2000	custom
SL4-2000/38	38	35	93	88	40	2000	2200	custom
SL4-2200/38	38	35	93	88	40	2200	2400	custom
SL4-2400/38	38	35	93	88	40	2400	2600	custom

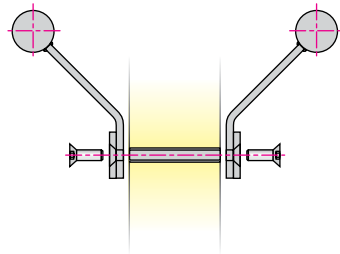
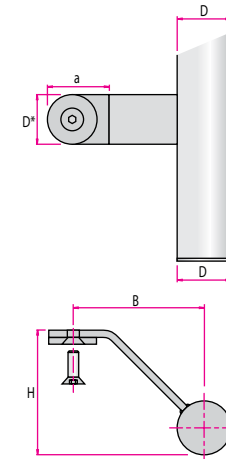

City Oak

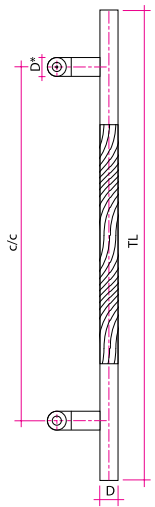
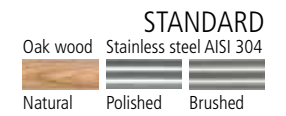
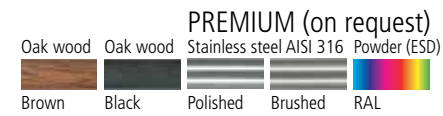

City Oak PSL

CODE	D	D*	B	H	a	c/c	TL	FIXING
PSL-600/32	32	35	90	82	40	600	800	custom
PSL-800/32	32	35	90	82	40	800	1000	custom
PSL-600/38	38	35	93	88	40	600	800	custom
PSL-800/38	38	35	93	88	40	800	1000	custom
PSL-1000/38	38	35	93	88	40	1000	1200	custom
PSL-1200/38	38	35	93	88	40	1200	1400	custom
PSL-1800/50	50	35	99	100	40	1800	2000	custom
PSL-2000/50	50	35	99	100	40	2000	2200	custom
PSL-2200/50	50	35	99	100	40	2200	2400	custom
PSL-2400/50	50	35	99	100	40	2400	2600	custom

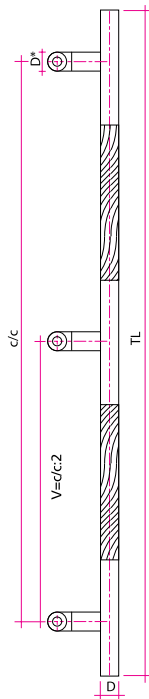
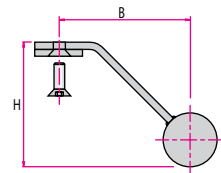
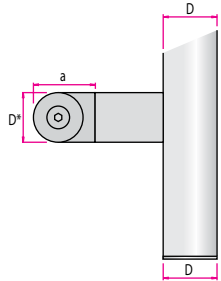

City Oak PSL3

CODE	D	D*	B	H	a	c/c	TL	FIXING
PSL3-1000/32	32	35	90	82	40	1000	1200	custom
PSL3-1200/32	32	35	90	82	40	1200	1400	custom
PSL3-1400/32	32	35	90	82	40	1400	1600	custom
PSL3-1600/32	32	35	90	82	40	1600	1800	custom
PSL3-1800/32	32	35	90	82	40	1800	2000	custom
PSL3-1200/38	38	35	93	88	40	1200	1400	custom
PSL3-1400/38	38	35	93	88	40	1400	1600	custom
PSL3-1600/38	38	35	93	88	40	1600	1800	custom
PSL3-1800/38	38	35	93	88	40	1800	2000	custom
PSL3-2000/38	38	35	93	88	40	2000	2200	custom

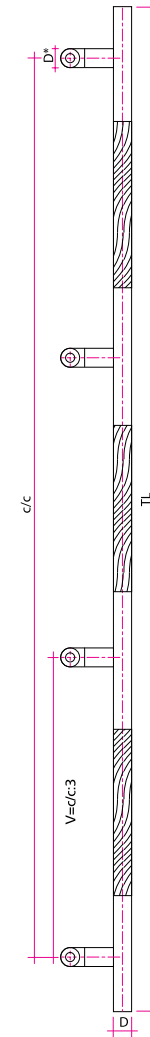

City Oak PSL4

CODE	D	D*	B	H	a	c/c	TL	FIXING
PSL4-1600/32	32	35	90	82	40	1600	1800	custom
PSL4-1800/32	32	35	90	82	40	1800	2000	custom
PSL4-2000/32	32	35	90	82	40	2000	2200	custom
PSL4-2200/32	32	35	90	82	40	2200	2400	custom
PSL4-2400/32	32	35	90	82	40	2400	2600	custom
PSL4-1600/38	38	35	93	88	40	1600	1800	custom
PSL4-1800/38	38	35	93	88	40	1800	2000	custom
PSL4-2000/38	38	35	93	88	40	2000	2200	custom
PSL4-2200/38	38	35	93	88	40	2200	2400	custom
PSL4-2400/38	38	35	93	88	40	2400	2600	custom

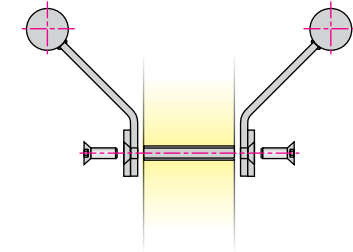

City

PREMIUM (on request)
Stainless steel AISI 316 Powder (ESD)

Polished Brushed RAL

STANDARD
Stainless steel AISI 304

Polished Brushed

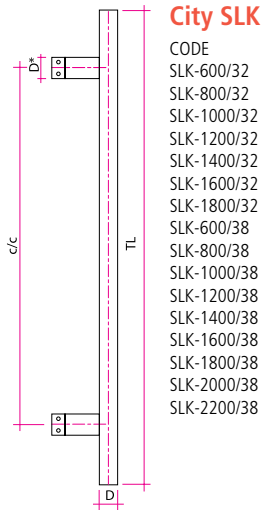

City SLK

CODE	D	D*	B	H	a	d	e	c/c	TL	FIXING
SLK-600/32	32	40	80	82	25	22	6	600	800	custom
SLK-800/32	32	40	80	82	25	22	6	800	1000	custom
SLK-1000/32	32	40	80	82	25	22	6	1000	1200	custom
SLK-1200/32	32	40	80	82	25	22	6	1200	1400	custom
SLK-1400/32	32	40	80	82	25	22	6	1400	1600	custom
SLK-1600/32	32	40	80	82	25	22	6	1600	1800	custom
SLK-1800/32	32	40	80	82	25	22	6	1800	2000	custom
SLK-600/38	38	40	83	88	25	22	6	600	800	custom
SLK-800/38	38	40	83	88	25	22	6	800	1000	custom
SLK-1000/38	38	40	83	88	25	22	6	1000	1200	custom
SLK-1200/38	38	40	83	88	25	22	6	1200	1400	custom
SLK-1400/38	38	40	83	88	25	22	6	1400	1600	custom
SLK-1600/38	38	40	83	88	25	22	6	1600	1800	custom
SLK-1800/38	38	40	83	88	25	22	6	1800	2000	custom
SLK-2000/38	38	40	83	88	25	22	6	2000	2200	custom
SLK-2200/38	38	40	83	88	25	22	6	2200	2400	custom

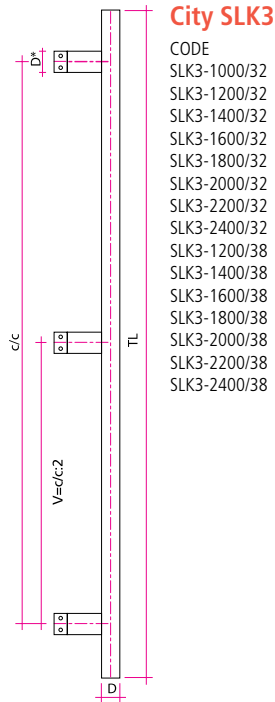

City SLK3

CODE	D	D*	B	H	a	d	e	c/c	TL	FIXING
SLK3-1000/32	32	40	80	82	25	22	6	1000	1200	custom
SLK3-1200/32	32	40	80	82	25	22	6	1200	1400	custom
SLK3-1400/32	32	40	80	82	25	22	6	1400	1600	custom
SLK3-1600/32	32	40	80	82	25	22	6	1600	1800	custom
SLK3-1800/32	32	40	80	82	25	22	6	1800	2000	custom
SLK3-2000/32	32	40	80	82	25	22	6	2000	2200	custom
SLK3-2200/32	32	40	80	82	25	22	6	2200	2400	custom
SLK3-2400/32	32	40	80	82	25	22	6	2400	2600	custom
SLK3-1200/38	38	40	83	88	25	22	6	1200	1400	custom
SLK3-1400/38	38	40	83	88	25	22	6	1400	1600	custom
SLK3-1600/38	38	40	83	88	25	22	6	1600	1800	custom
SLK3-1800/38	38	40	83	88	25	22	6	1800	2000	custom
SLK3-2000/38	38	40	83	88	25	22	6	2000	2200	custom
SLK3-2200/38	38	40	83	88	25	22	6	2200	2400	custom
SLK3-2400/38	38	40	83	88	25	22	6	2400	2600	custom

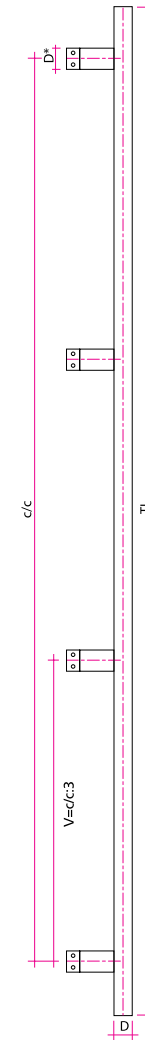

City SLK4

CODE	D	D*	B	H	a	d	e	c/c	TL	FIXING
SLK4-1600/32	32	40	80	82	25	22	6	1600	1800	custom
SLK4-1800/32	32	40	80	82	25	22	6	1800	2000	custom
SLK4-2000/32	32	40	80	82	25	22	6	2000	2200	custom
SLK4-2200/32	32	40	80	82	25	22	6	2200	2400	custom
SLK4-2400/32	32	40	80	82	25	22	6	2400	2600	custom
SLK4-1600/38	38	40	83	88	25	22	6	1600	1800	custom
SLK4-1800/38	38	40	83	88	25	22	6	1800	2000	custom
SLK4-2000/38	38	40	83	88	25	22	6	2000	2200	custom
SLK4-2200/38	38	40	83	88	25	22	6	2200	2400	custom
SLK4-2400/38	38	40	83	88	25	22	6	2400	2600	custom

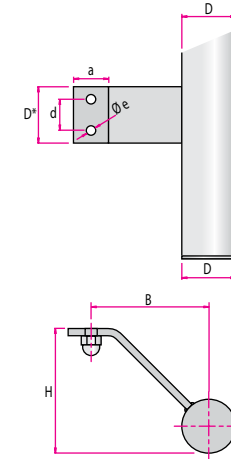

City Oak

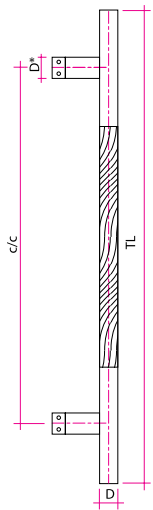
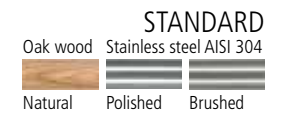
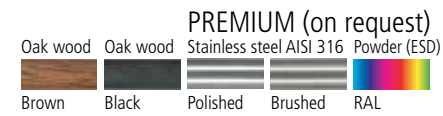

City Oak PSLK

CODE	D	D*	B	H	a	d	e	c/c	TL	FIXING
PSLK-600/32	32	40	80	82	25	22	6	600	800	custom
PSLK-800/32	32	40	80	82	25	22	6	800	1000	custom
PSLK-600/38	38	40	83	88	25	22	6	600	800	custom
PSLK-800/38	38	40	83	88	25	22	6	800	1000	custom
PSLK-1000/38	38	40	83	88	25	22	6	1000	1200	custom
PSLK-1200/38	38	40	83	88	25	22	6	1200	1400	custom
PSLK-1800/50	50	40	89	100	25	22	6	1800	2000	custom
PSLK-2000/50	50	40	89	100	25	22	6	2000	2200	custom
PSLK-2000/50	50	40	89	100	25	22	6	2000	2200	custom
PSLK-2200/50	50	40	89	100	25	22	6	2200	2400	custom
PSLK-2400/50	50	40	89	100	25	22	6	2400	2600	custom

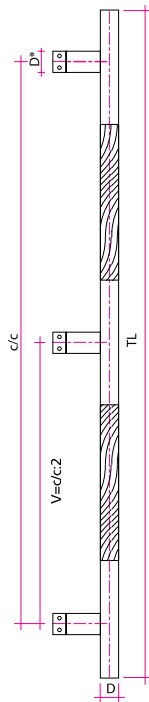
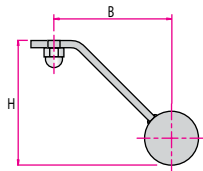
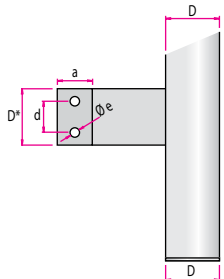

City Oak PSLK3

CODE	D	D*	B	H	a	d	e	c/c	TL	FIXING
PSLK3-1000/32	32	40	80	82	25	22	6	1000	1200	custom
PSLK3-1200/32	32	40	80	82	25	22	6	1200	1400	custom
PSLK3-1400/32	32	40	80	82	25	22	6	1400	1600	custom
PSLK3-1600/32	32	40	80	82	25	22	6	1600	1800	custom
PSLK3-1800/32	32	40	80	82	25	22	6	1800	2000	custom
PSLK3-1200/38	38	40	83	88	25	22	6	1200	1400	custom
PSLK3-1400/38	38	40	83	88	25	22	6	1400	1600	custom
PSLK3-1600/38	38	40	83	88	25	22	6	1600	1800	custom
PSLK3-1800/38	38	40	83	88	25	22	6	1800	2000	custom
PSLK3-2000/38	38	40	83	88	25	22	6	2000	2200	custom

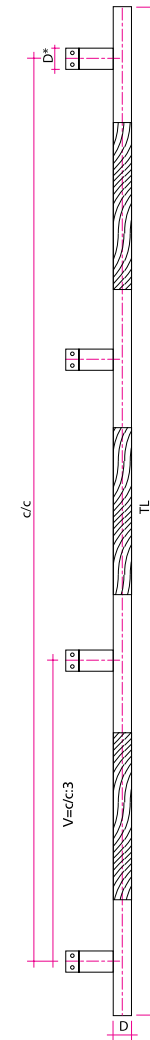

City Oak PSLK4

CODE	D	D*	B	H	a	d	e	c/c	TL	FIXING
PSLK4-1600/32	32	40	80	82	25	22	6	1600	1800	custom
PSLK4-1800/32	32	40	80	82	25	22	6	1800	2000	custom
PSLK4-2000/32	32	40	80	82	25	22	6	2000	2200	custom
PSLK4-2200/32	32	40	80	82	25	22	6	2200	2400	custom
PSLK4-2400/32	32	40	80	82	25	22	6	2400	2600	custom
PSLK4-1600/38	38	40	83	88	25	22	6	1600	1800	custom
PSLK4-1800/38	38	40	83	88	25	22	6	1800	2000	custom
PSLK4-2000/38	38	40	83	88	25	22	6	2000	2200	custom
PSLK4-2200/38	38	40	83	88	25	22	6	2200	2400	custom
PSLK4-2400/38	38	40	83	88	25	22	6	2400	2600	custom



Majestic

Majestic PRLF

CODE	D	H	c/c	TL	a	b	c	d	e	FIXING
PRLF-2000/50	50	100	2000	2040	40	60	20	35	8	custom
PRLF-2200/50	50	100	2200	2240	40	60	20	35	8	custom
PRLF-2400/50	50	100	2400	2440	40	60	20	35	8	custom

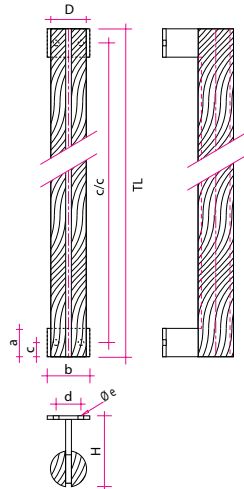

Majestic PQLF

CODE	W	P	H	c/c	TL	a	b	c	d	e	FIXING
PQLF-2000/50	50	50	100	2000	2040	40	60	20	35	8	custom
PQLF-2200/50	50	50	100	2200	2240	40	60	20	35	8	custom
PQLF-2400/50	50	50	100	2400	2440	40	60	20	35	8	custom

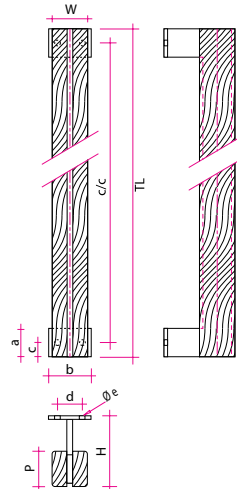

Majestic

PREMIUM (on request)
Oak wood Oak wood Stainless steel AISI 316 Powder (ESD)
Brown Black Polished Brushed RAL

STANDARD
Oak wood Stainless steel AISI 304
Natural Polished Brushed

Majestic PRLS

CODE	D	D*	H	c/c	TL	FIXING
PRLS-2000/50	50	30	100	2000	2040	O
PRLS-2200/50	50	30	100	2200	2240	O
PRLS-2400/50	50	30	100	2400	2440	O

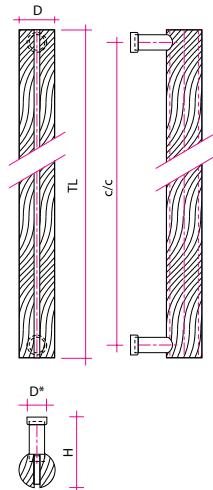

Majestic PQLS

CODE	W	P	D*	H	c/c	TL	FIXING
PQLS-2000/50	50	50	30	100	2000	2040	O
PQLS-2200/50	50	50	30	100	2200	2240	O
PQLS-2400/50	50	50	30	100	2400	2440	O

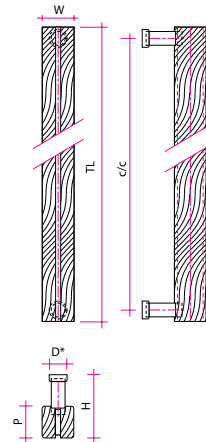

ORDER SPECIFICATION CODE

Based on the code system here you should be able to specify the handle type, material and finish, and the type of fixing nut you would like suiting to door thickness. **Please specify in a similar way to the following example:**

Double-sided door handle (pair)

Sample code specification:

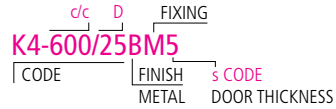

Single-sided door handle (piece)

Sample code specification:

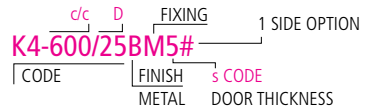

Single-sided handles (pieces)

= Fixing guide, not through door

Fixing guide, through door

METAL & FINISH

Please specify metal or wood finish.

B Brushed Stainless Steel

P Polished Stainless Steel



RAL Powder coating (ESD)

C Polished Brass CuZn



Wood Natural

Wood Brown

Wood Black



FIXING

Handles are available with a variety of round or hexagonal fixing nuts.

Please specify **M, V, S, O, K, X, A** fixing, based on the table of fixing nuts shown here.

If **M, V** fixing, please specify for **Right Hand RH** or **Left Hand LH** opening doors.

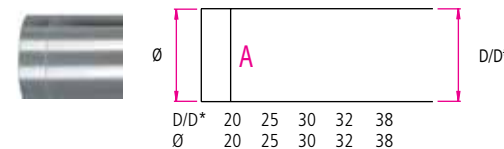
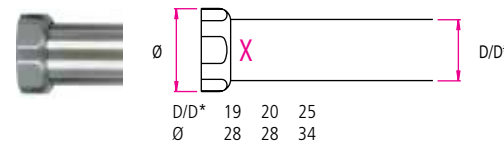
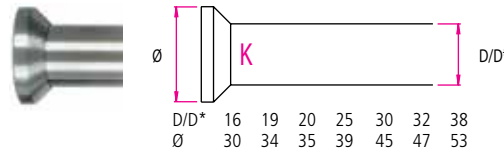
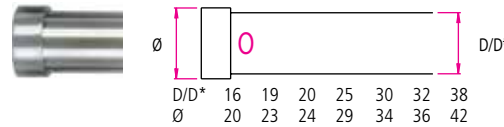
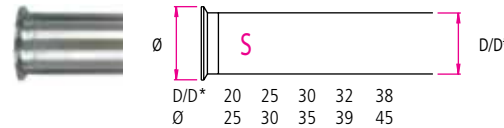
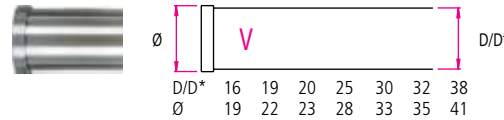
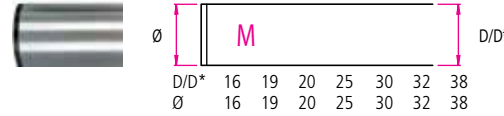

DOOR THICKNESS s min. 5 mm

Please specify length of fixing bolt using the **s CODE** based on the thickness of the door.

Handles are suitable for doors or all materials.

s DOOR THICKNESS	s CODE
5 – 25 mm	1
25 – 40 mm	2
40 – 55 mm	3
55 – 70 mm	4
70 – 85 mm	5
85 – 100 mm	6

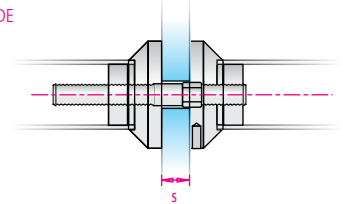

FLANGE FIXING

Flange F, FD

Double-sided door handle (pair) Sample code specification:

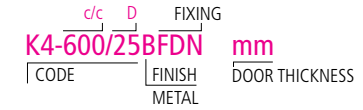

Single-sided door handle (piece) Sample code specification:

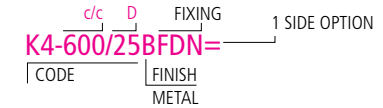

N (Nut) Flange nut

H (Hidden) Flange screw

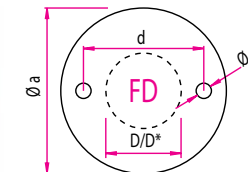

D/D*	19	20	25	30	32	38
Ø a	45	45	55	60	60	70
d	32	32	40	47	47	54
e	5	5	5	5	5	6

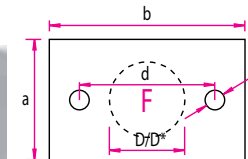

D/D*	19	20	25
a	30	30	40
b	55	55	65
d	40	40	45
e	6	6	6

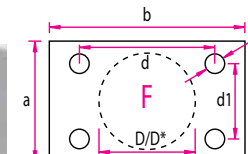

D/D*	30	32
a	40	40
b	65	65
d	45	45
d1	25	25
e	6	6

Fixing guides

Opening diameter drilled for fixing bolt: Glass door = 12mm. Doors of all other materials = 10mm.
 If not M, V, S, O, K, X or A fixing, then opening diameter drilled should be made to suit the fixing bolt.

M or V fixing

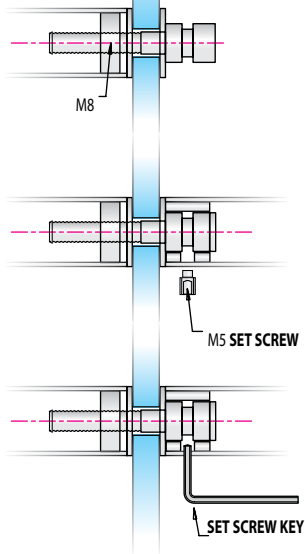

Double-sided handles (pair)

M, V Fixing guide

1. Start installation by turning the bolt to fix the external handle to the door.
2. Align the inside handle to allow bolt head to be inserted.
3. Push the inside handle against the door and turn the set screw steadily clockwise using the set screw key.

M or V fixing, single-sided, set screw = Not through door

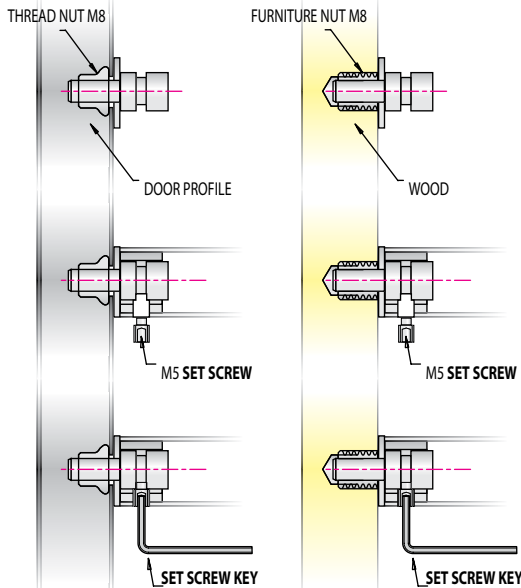

Single-sided handles (pieces)

Set screw, Fixing guide

1. Start installation by turning the bolt tightly into the thread nut or furniture nut in the door.
 2. Align the door handle with the bolts.
 3. Push the handle against the door and turn the set screw steadily clockwise using the set screw key.
- Note: the furniture nut M8 or the thread nut M8 are **not supplied** with the handles.

S, O, K, X or A fixing

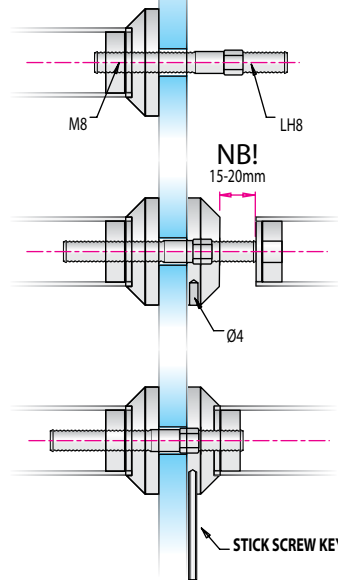

Double-sided handles (pair)

S, O, K, X, A Fixing guide

1. Start installation by turning the bolt to fix the external handle to the door.
2. The screw with the nut (six-facet) must remain inside of the door.
3. Twist the screw so far that it remains 10 mm out from the outer side of the nut.
4. The inside door handle has a left handed thread which attaches to the bolt. Using the stick screw key turn the fixing nut steadily clockwise until it is tight.

S, O, K, X or A fixing, single-sided, stick screw = Not through door

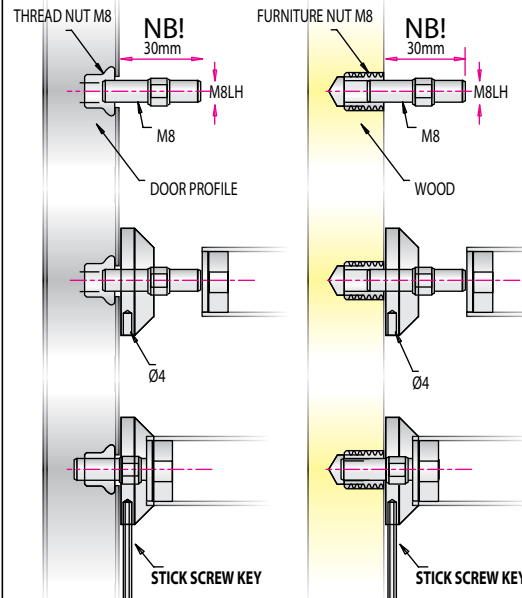

Single-sided handles (pieces)

Stick screw, Fixing guide

- NB! In the case of the headless bolt M8, the bolt should be screwed in so that it remains protruding by 30mm.
1. Align the door handle with the bolts.
 2. Push the handle against the door.
 3. The door handle has a left handed thread which attaches to the bolt. Using the stick screw key turn the fixing nut steadily clockwise until it is tight.
- Note: the furniture nut M8 or the thread nut M8 are **not supplied** with the handles.

M, V, S, O, K, X or A fixing # Through door

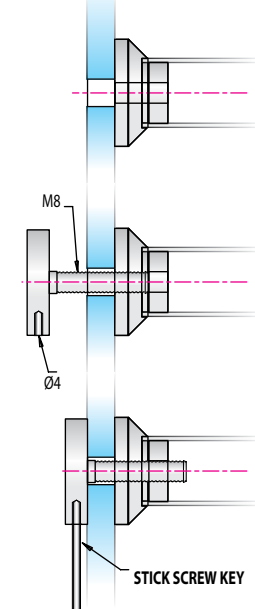

Single-sided handles (pieces)

Fixing guide

1. Align the door handle with drilled holes.
2. Place bolts to align with handle.
3. The door handle has a right handed thread which attaches to the bolt. Using the stick screw key turn the fixing nut steadily clockwise until it is tight.

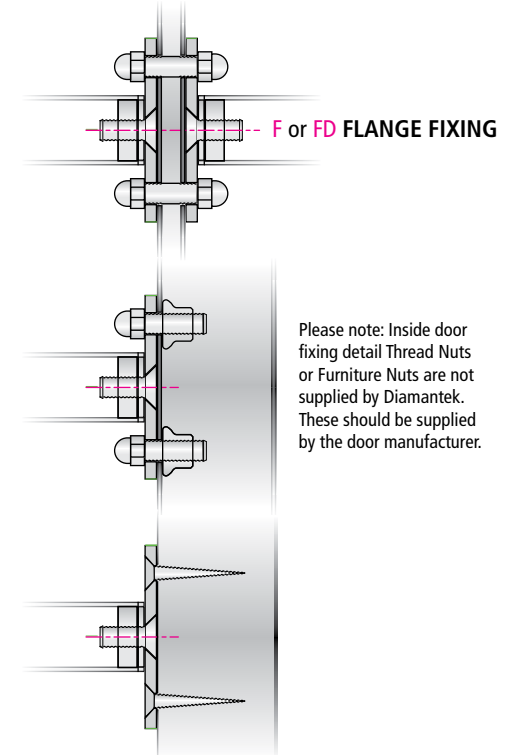

Please note: Inside door fixing detail Thread Nuts or Furniture Nuts are not supplied by Diamantek. These should be supplied by the door manufacturer.



QUALITY ASSURANCE

Diamantek offers you a commitment to excellent workmanship with attention to detail and precision manufacturing. Since the year 2000, we have been steadily expanding our range of handle shapes, styles and materials.

The pull handles are fully reliable in the absorption of pressure and tension forces and fixing systems have been well tested.

Installation is easy with standard drilling and screwing techniques.

SPECIAL ORDERS

In addition to the products in this catalogue, non-standard and custom pull handles are also available to meet clients special requirements.



DIAMANTEK
DOOR HANDLE FACTORY

Diamantek Ltd.
Savimäe 4, Vahi alevik,
Tartumaa 60534, Estonia
Tel +372 736 2682
diamantek@diamantek.ee
www.diamantek.ee

